



## INSTRUCTION MANUAL

# CLASS B AIS TRANSPONDER **MA-510TR**



This device complies with Part 15 of the FCC rules. Operation is subject to the following two conditions: (1) This device may not cause harmful interference, and (2) this device must accept any interference received, including interference that may cause undesired operation.

Thank you for choosing this Icom product.

This product was designed and built with Icom's state of the art technology and craftsmanship. With proper care, this product should provide you with years of trouble-free operation.

## ■ Important

**READ ALL INSTRUCTIONS** carefully and completely before using the transponder.

**SAVE THIS INSTRUCTION MANUAL** — This instruction manual contains important operating instructions for the MA-510TR.

This instruction manual includes some functions that are usable only when they are preset by your dealer. Ask your dealer for details.

## ■ Features

- Large and high contrast 4.3-inch color TFT LCD
- NMEA0183/NMEA 2000/USB connectivity
- Navigation function
- Multi-language interface (English, French, Indonesian, Spanish, and Vietnamese)

Icom is not responsible for the destruction, damage to, or performance of any Icom or non-Icom equipment, if the malfunction is because of:

- Force majeure, including, but not limited to, fires, earthquakes, storms, floods, lightning, other natural disasters, disturbances, riots, war, or radioactive contamination.
- The use of Icom transponders with any equipment that is not manufactured or approved by Icom.

## ■ Explicit definitions

WORD	DEFINITION
<b>⚠ WARNING!</b>	Personal injury, fire hazard or electric shock may occur.
<b>CAUTION</b>	Equipment damage may occur.
<b>NOTE</b>	If disregarded, inconvenience only. No risk of personal injury, fire or electric shock.

## ■ Définitions explicites

TERME	DÉFINITION
<b>⚠ AVERTISSEMENT!</b>	Risque de blessures corporelles, d'incendie ou de choc électrique.
<b>MISE EN GARDE</b>	Risque de dégât matériel.
<b>REMARQUE</b>	Inconvénient seulement, en cas de nonrespect. Absence de risque de blessures corporelles, d'incendie ou de choc électrique.

Icom, Icom Inc. and the Icom logo are registered trademarks of Icom Incorporated (Japan) in Japan, the United States, the United Kingdom, Germany, France, Spain, Russia, Australia, New Zealand, and/or other countries.

All other products or brands are registered trademarks or trademarks of their respective holders.

---

## ■ Recommendation

**CLEAN THE TRANSPONDER THOROUGHLY WITH FRESH WATER** after exposure to saltwater, and dry it before operating. Otherwise, the transponder's keys, switches and controllers may become unusable, due to salt crystallization.

① The DC power cable does not meet IPX7.

**NOTE:** If the transponder's waterproof protection appears defective, carefully clean it with a soft, wet (fresh water) cloth, then dry it before operating. The transponder may lose its waterproof protection if the case or connector is cracked or broken, or the transponder has been dropped. Contact your Icom distributor or your dealer for advice.

## ■ Installation note

### Installation:

The installation of this equipment should be made in such a manner as to respect the EC recommended electromagnetic field exposure limits. (1999/519/EC)

The maximum RF power available from this device is 2 watts. The antenna should be installed as high as possible for maximum efficiency and the installation height should be at least 0.4 meters above any accessible position. In the case where an antenna cannot be installed at a reasonable height, then the transmitter should neither be continuously operated for long periods if any person is within a distance of 0.4 meters of the antenna, nor operated at all if any person is touching the antenna.

It is recommended that antenna of a maximum gain of 3 dB is used. If higher gain antenna is required then please contact your Icom distributor for revised installation recommendations.

### Operation:

The exposure to RF electromagnetic field is only applicable when this device is transmitting. This exposure is naturally reduced due to the nature of alternating periods of receiving and transmitting. Keep your transmissions to the minimum necessary.

## ■ About CE and DOC

 Hereby, Icom Inc. declares that the versions of MA-510TR which have the "CE" symbol on the product, comply with the essential requirements of the Radio Equipment Directive, 2014/53/EU, and the restriction of the use of certain hazardous substances in electrical and electronic equipment Directive, 2011/65/EU. The full text of the EU declaration of conformity is available at the following internet address:  
<http://www.icom.co.jp/world/support>

## ■ Disposal



 The crossed-out wheeled-bin symbol on your product, literature, or packaging reminds you that in the European Union, all electrical and electronic products, batteries, and accumulators (rechargeable batteries) must be taken to designated collection locations at the end of their working life. Do not dispose of these products as unsorted municipal waste. Dispose of them according to the laws in your area.

---

## ■ Radio operation warning



Icom requires the radio operator to meet the FCC Requirements for Radio Frequency Exposure. An omnidirectional antenna with gain not greater than 9 dBi must be mounted a minimum of 5 meters (measured from the lowest point of the antenna) vertically above the main deck and all possible personnel. This is the minimum safe separation distance estimated to meet all RF exposure compliance requirements. This 5 meter distance is based

on the FCC Safe Maximum Permissible Exposure (MPE) distance of 3 meters added to the height of an adult (2 meters) and is appropriate for all vessels.

For watercraft without suitable structures, the antenna must be mounted so as to maintain a minimum of 1 meter vertically between the antenna, (measured from the lowest point of the antenna), to the heads of all persons AND all persons must stay outside of the 3 meter MPE radius.

Do not transmit with radio and antenna when persons are within the MPE radius of the antenna, unless such persons (such as driver or radio operator) are shielded from antenna field by a grounded metallic barrier. The MPE Radius is the minimum distance from the antenna axis that person should maintain in order to avoid RF exposure higher than the allowable MPE level set by FCC.

**FAILURE TO OBSERVE THESE LIMITS MAY ALLOW THOSE WITHIN THE MPE RADIUS TO EXPERIENCE RF RADIATION ABSORPTION WHICH EXCEEDS THE FCC MAXIMUM PERMISSIBLE EXPOSURE (MPE) LIMIT. IT IS THE RESPONSIBILITY OF THE RADIO OPERATOR TO ENSURE THAT THE MAXIMUM PERMISSIBLE EXPOSURE LIMITS ARE OBSERVED AT ALL TIMES DURING RADIO TRANSMISSION. THE RADIO OPERATOR IS TO ENSURE THAT NO BYSTANDERS COME WITHIN THE RADIUS OF THE MAXIMUM PERMISSIBLE EXPOSURE LIMITS.**

### Determining MPE Radius

**THE MAXIMUM PERMISSIBLE EXPOSURE (MPE) RADIUS HAS BEEN ESTIMATED TO BE A RADIUS OF ABOUT 3M PER OET BULLETIN 65 OF THE FCC. THIS ESTIMATE IS MADE ASSUMING THE MAXIMUM POWER OF THE RADIO AND ANTENNAS WITH A MAXIMUM GAIN OF 9dBi ARE USED FOR A SHIP MOUNTED SYSTEM.**

---

## ■ Avertissement pour les opérateurs radio



### AVERTISSEMENT

Icom exige que l'opérateur radio se conforme aux exigences de la FCC en matière d'exposition aux radiofréquences. Une antenne omnidirectionnelle dont le gain ne dépasse pas 9dBi doit être fixée à une distance minimale de 5 mètres (mesurée depuis le point le plus bas de l'antenne) verticalement au-dessus du pont principal et de tout le personnel qui peut s'y trouver. Il s'agit de la distance de sécurité minimale prévue pour satisfaire aux exigences de conformité en matière d'exposition aux RF. Cette distance de 5 mètres est établie en fonction de l'exposition maximale admissible sécuritaire de 3 mètres établie par la FCC, à laquelle on ajoute la hauteur d'un adulte (2 mètres); cette distance convient pour tous les navires.

Dans le cas des embarcations sans structure convenable, l'antenne doit être fixée de façon à maintenir une distance minimale de 1 mètre verticalement entre cette antenne (mesurée depuis son point le plus bas) et la tête de toute personne présente; toutes les personnes présentes doivent se tenir à l'extérieur d'un rayon d'exposition maximale admissible de 3 mètres.

Ne pas émettre à l'aide de la radio et de l'antenne lorsque des personnes se trouvent à l'intérieur du rayon d'exposition maximale admissible de cette antenne, à moins que ces personnes (comme le conducteur ou l'opérateur radio) ne soient protégées du champ de l'antenne par un écran métallique relié à la masse. Le rayon d'exposition maximale admissible équivaut à la distance minimale que cette personne doit maintenir entre elle et l'axe de l'antenne pour éviter une exposition aux RF supérieure au niveau d'exposition maximale admissible fixé par la FCC.

**LE NON-RESPECT DE CES LIMITES PEUT CAUSER, POUR LES PERSONNES SITUÉES DANS LE RAYON D'EXPOSITION MAXIMALE ADMISSIBLE, UNE ABSORPTION DE RAYONNEMENT DE RF SUPÉRIEURE À L'EXPOSITION MAXIMALE ADMISSIBLE FIXÉE PAR LA FCC.**

**L'OPÉRATEUR RADIO EST RESPONSABLE D'ASSURER QUE LES LIMITES D'EXPOSITION MAXIMALE ADMISSIBLE SOIENT RESPECTÉES EN TOUT TEMPS PENDANT LA TRANSMISSION RADIO. L'OPÉRATEUR RADIO DOIT S'ASSURER QU'AUCUNE PERSONNE PRÉSENTE NE SE SITUE À L'INTÉRIEUR DU RAYON D'EXPOSITION MAXIMALE ADMISSIBLE.**

**Établir le rayon d'exposition maximale admissible**

**ON ESTIME QUE LE RAYON D'EXPOSITION MAXIMALE ADMISSIBLE EST D'ENVIRON 3 M, TEL QUE STIPULÉ DANS LE BULLETIN OET 65 DE LA FCC. CETTE DISTANCE ESTIMÉE TIEN COMPTE D'UN SYSTÈME INSTALLÉ SUR UN NAVIRE UTILISANT LA PUISSANCE MAXIMALE DE LA RADIO ET DES ANTENNES DONT LE GAIN MAXIMAL EST DE 9dBi.**

**Determining MPE Radius**

**THE MAXIMUM PERMISSIBLE EXPOSURE (MPE) RADIUS HAS BEEN ESTIMATED TO BE A RADIUS OF ABOUT 3M PER OET BULLETIN 65 OF THE FCC. THIS ESTIMATE IS MADE ASSUMING THE MAXIMUM POWER OF THE RADIO AND ANTENNAS WITH A MAXIMUM GAIN OF 9dBi ARE USED FOR A SHIP MOUNTED SYSTEM.**

---

## ■ Precautions

⚠ **WARNING! NEVER** connect the transponder directly to an AC outlet. This may cause a fire or an electric shock.

⚠ **WARNING! NEVER** connect the transponder to a power source of more than 31 V DC. This connection could cause a fire or damage the transponder.

⚠ **WARNING! NEVER** reverse the DC power cable polarity. This could cause a fire or damage the equipment.

⚠ **WARNING! NEVER** cut the DC power cable between the DC power connector on the transponder's rear panel and the fuse holder. If an incorrect connection is made after cutting, the transponder may be damaged.

⚠ **WARNING! NEVER** operate the transponder during a lightning storm. It may result in an electric shock, cause a fire or damage the transponder. Always disconnect the power source and antenna before a storm.

⚠ **WARNING! NEVER** place the transponder where normal operation of the vessel may be hindered, or where it could cause bodily injury.

**CAUTION: DO NOT** place or leave the transponder in areas with temperatures below  $-20^{\circ}\text{C}$   $\sim$   $+60^{\circ}\text{C}$  ( $-4^{\circ}\text{F}$   $\sim$   $+140^{\circ}\text{F}$ ), or in areas subject to direct sunlight, such as a dashboard.

**CAUTION: DO NOT** use harsh solvents such as Benzine or alcohol when cleaning. This could damage the equipment surfaces. If the surface becomes dusty or dirty, wipe it clean with a soft, dry cloth.

**BE CAREFUL!** The transponder's rear panel will become hot when transmitting continuously for long periods of time.

**BE CAREFUL!** The transponder meets IPX7 requirements for waterproof protection. However, once the transponder has been dropped, or the waterproof seal is cracked or damaged, waterproof protection cannot be guaranteed because of possible damage to the case or the waterproof seal.

① The DC power cable does not meet IPX7.

**NOTE:** Install the transponder more than 1 meter (3.3 ft) from the vessel's magnetic navigation compass.

**NOTE:** Place the transponder in a secure place to avoid inadvertent use by unauthorized persons.

### ◇ GPS antenna

**CAUTION: DO NOT** use or place the GPS antenna in areas with temperatures below  $-30^{\circ}\text{C}$  ( $-22^{\circ}\text{F}$ ) or above  $+85^{\circ}\text{C}$  ( $+185^{\circ}\text{F}$ ).

**BE CAREFUL!** The GPS antenna meets IPX7 requirements for waterproof protection. However, once the GPS antenna has been dropped, or the waterproof seal is cracked or damaged, waterproof protection cannot be guaranteed because of possible damage to the case or the waterproof seal.

---

## ■ Précautions

⚠ **AVERTISSEMENT ! NE JAMAIS** relier le transpondeur à une prise CA. Cela pourrait provoquer un choc électrique ou un incendie.

⚠ **AVERTISSEMENT ! NE JAMAIS** brancher le transpondeur sur une source d'alimentation supérieure à 31 V CC. Cela pourrait endommager le transpondeur.

⚠ **AVERTISSEMENT ! NE JAMAIS** inverser la polarité du câble d'alimentation CC lors de la connexion à une source d'alimentation. Cela pourrait endommager l'émetteur-récepteur.

⚠ **AVERTISSEMENT ! NE JAMAIS** couper le câble d'alimentation CC entre la prise CC à l'arrière de le transpondeur et le porte-fusible. Le transpondeur peut être endommagé par la suite en cas de connexion inappropriée.

⚠ **AVERTISSEMENT ! NE JAMAIS** utiliser le transpondeur durant un orage. Cela risquerait de provoquer un choc électrique, un incendie ou d'endommager le transpondeur. Toujours débrancher la source d'alimentation et l'antenne avant une tempête.

⚠ **AVERTISSEMENT ! NE JAMAIS** installer le transpondeur à un emplacement où il pourrait gêner le fonctionnement normal du navire ou provoquer des blessures corporelles.

**MISE EN GARDE : NE PAS** utiliser ou placer le transpondeur dans des zones où la température est inférieure à  $-20^{\circ}\text{C}$  ( $-4^{\circ}\text{F}$ ) ou supérieure à  $+60^{\circ}\text{C}$  ( $+140^{\circ}\text{F}$ ) ou dans des zones soumises au rayonnement solaire direct, telles le tableau de bord.

**MISE EN GARDE : NE PAS** utiliser de dissolvants agressifs tels que du Benzène ou de l'alcool lors du nettoyage, car ils endommageraient les surfaces de le transpondeur. Si le transpondeur est poussiéreux ou sale, nettoyez-le avec un tissu doux et sec.

**MISE EN GARDE :** La face arrière de le transpondeur chauffe en cas d'utilisation continue sur une longue durée.

**MISE EN GARDE :** Le transpondeur est étanche conformément à la norme IPX7. L'étanchéité ne peut plus être garantie après une chute de l'appareil en raison des risques de fissures du boîtier, de dégradation du joint d'étanchéité, etc.

① Le câble d'alimentation CC ne sont pas conformes à IPX7.

**REMARQUE: INSTALLER** le transpondeur et le microphone à au moins 1 m (3.3 ft) du compas de route du navire.

**REMARQUE:** Placer le transpondeur hors de portée des enfants pour éviter toute utilisation inopinée.

Si la face avant est exposée à de l'eau de mer, **ASSUREZ-VOUS DE LE NETTOYER ENTIÈREMENT AVEC DE L'EAU DOUCE** lorsque la protection étanche sur le panneau avant fonctionne. Dans le cas contraire, les touches et le commutateur risquent de ne plus fonctionner en raison de la cristallisation du sel.

## ◇ Antenne GPS

**MISE EN GARDE : NE PAS** utiliser ou placer l'antenne GPS dans des zones soumises à des températures inférieures à  $-30^{\circ}\text{C}$  ( $-22^{\circ}\text{F}$ ) ou supérieures à  $+85^{\circ}\text{C}$  ( $+185^{\circ}\text{F}$ ).

**MISE EN GARDE :** L'antenne GPS est étanche conformément à la norme IPX7. L'étanchéité ne peut plus être garantie après une chute de l'appareil en raison des risques de fissures du boîtier, de dégradation du joint d'étanchéité, etc.

---

## ■ FCC information

This equipment has been tested and found to comply with the limits for a Class A digital device, pursuant to part 15 of the FCC Rules. These limits are designed to provide reasonable protection against harmful interference when the equipment is operated in a commercial environment. This equipment generates, uses, and can radiate radio frequency energy and, if not installed and used in accordance with the instruction manual, may cause harmful interference to radio communications.

Operation of this equipment in a residential area is likely to cause harmful interference in which case the user will be required to correct the interference at his own expense.

**CAUTION:** Changes or modifications to this transponder, not expressly approved by Icom Inc., could void your authority to operate this transponder under FCC regulations.

## ■ Information FCC

Cet équipement a été testé et reconnu conforme aux limites fixées pour un appareil numérique de classe A, conformément au point 15 de la réglementation FCC. Ces limites sont définies de façon à fournir une protection raisonnable contre le brouillage préjudiciable lorsque cet appareil est utilisé dans un environnement commercial. Cet équipement génère, utilise et peut émettre un rayonnement de fréquence radio. S'il n'a pas été installé conformément aux instructions, il peut par ailleurs créer des interférences perturbant les communications radio.

L'utilisation de cet appareil dans une zone résidentielle peut provoquer un brouillage préjudiciable, auquel cas l'utilisateur sera tenu de corriger la situation à ses frais.

**MISE EN GARDE:** Tout changement ou modification, non expressément approuvé par Icom Inc., peut annuler l'autorisation de l'utilisateur à utiliser cet appareil conformément à la réglementation FCC.



---

## ■ Table of contents

■ Important.....	i	<b>8 CONNECTIONS AND INSTALLATION</b>	<b>38</b>
■ Features.....	i	■ Supplied accessories.....	38
■ Explicit definitions.....	i	■ GPS antenna connection.....	39
■ Définitions explicites.....	i	■ Connections.....	40
■ Recommendation.....	ii	■ Connecting to the transceiver.....	42
■ Installation note.....	ii	■ Fuse replacement.....	42
■ About CE and DOC.....	ii	■ Mounting the transponder.....	43
■ Disposal.....	ii	■ MB-132 installation.....	44
■ Radio operation warning.....	iii	<b>9 SPECIFICATIONS AND OPTIONS..</b>	<b>45</b>
■ Avertissement pour les opérateurs radio.....	iv	■ Specifications.....	45
■ Precautions.....	v	■ Options.....	46
■ Précautions.....	vi	<b>10 MAINTENANCE.....</b>	<b>47</b>
■ FCC information.....	vii	■ Troubleshooting.....	47
■ Information FCC.....	vii	■ Error messages.....	48
<b>1 OVERVIEW.....</b>	<b>1</b>	<b>11 AtoN CODE DESCRIPTION.....</b>	<b>49</b>
■ About AIS.....	1	<b>12 TEMPLATE.....</b>	<b>50</b>
■ AIS classes.....	1	<b>INDEX.....</b>	<b>52</b>
<b>2 PANEL DESCRIPTION.....</b>	<b>2</b>		
■ Front panel.....	2		
■ Function display.....	3		
<b>3 PREPARATION.....</b>	<b>4</b>		
■ Entering the MMSI code.....	4		
■ Entering Own ship data.....	5		
<b>4 MENU SCREEN.....</b>	<b>7</b>		
■ Menu construction.....	7		
■ Selecting a Menu item.....	8		
<b>5 BASIC OPERATION.....</b>	<b>9</b>		
■ Turning ON the transponder.....	9		
■ Backlight function.....	10		
■ Using the Main screen.....	11		
■ Using the AIS list screen.....	16		
■ Setting a Friend.....	18		
■ About the detail screen.....	19		
■ AIS settings.....	21		
<b>6 OTHER FUNCTIONS.....</b>	<b>23</b>		
■ Message.....	23		
■ Waypoint.....	24		
■ MOB (Man Overboard).....	27		
■ Navigation.....	28		
■ Lost target.....	30		
■ Individual DSC call.....	31		
<b>7 MENU ITEMS.....</b>	<b>32</b>		
■ Menu items.....	32		
■ Menu items description.....	33		

## ■ About AIS

The Automatic Identification System (AIS) is primarily used for collision-risk management and navigation safety. It may automatically transmit and receive vessel information, such as the vessel name, MMSI code, vessel type, position data, speed, course, destination, and more, depending on the class. Information is exchanged among vessels and/or base stations on the VHF maritime mobile band. The information helps to identify other nearby vessels or stations by displaying the received data on a plotter or a radar screen.

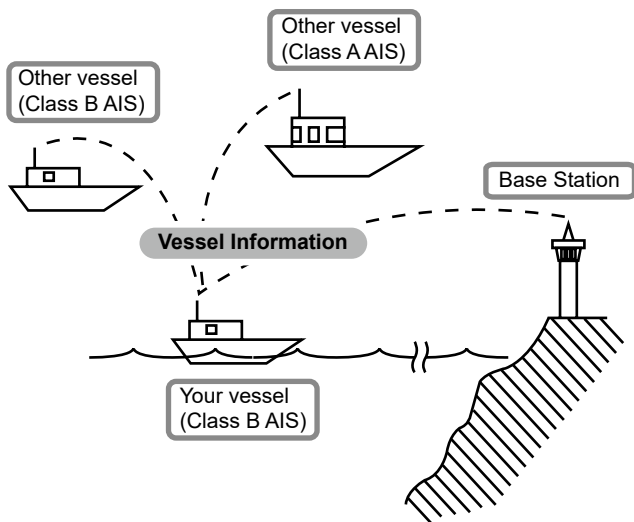

## ■ AIS classes

There are 7 types of AIS stations, vessels, base stations, Search and Rescue (SAR), Aids to Navigation (AtoN), Search and Rescue Transmitter (AIS-SART), Man OverBoard (MOB), and Emergency Position Indicating Radio Beacon-AIS (EPIRB-AIS).

There are 2 classes of AIS units, which are installed on vessels, Class A and Class B.

Under the Safety Of Life At Sea (SOLAS) convention, all SOLAS vessels are required to install a Class A AIS transponder:

A Class B AIS transponder is designed to be interoperability with Class A units, but not to impact the Class A network.

Many commercial vessels, and some leisure craft, not classified as requiring a Class A unit, choose to install a Class B unit to avoid accidents at sea.

## ■ Front panel

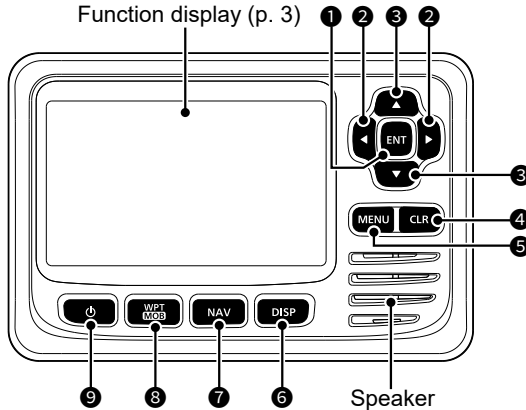

1  
2

- 1 ENTER KEY [ENT]**  
Push to set the entered data, selected item, and so on.
- 2 LEFT/RIGHT KEYS [◀]/[▶]**

  - Push to select an AIS target, and so on. (p. 11)
  - Push to select a character or number in the entry mode.
- 3 UP/DOWN KEYS [▲]/[▼]**

  - Push to select the Menu items, Menu settings, and so on. (p. 7)
  - Push [▲] or [▼] to select the display range on the plotter screen. (p. 12)
  - Push to select a character or number in the entry mode.
  - Push to select a voice channel in the voice channel selection screen. (p. 31)
- 4 CLEAR KEY [CLR]**  
Push to cancel the entered data, or to return to the previous screen.
- 5 MENU KEY [MENU]** (p. 8)  
Push to display or close the Menu screen.
- 6 DISPLAY KEY [DISP]** (p. 11)  
Push to switch the main screen between the AIS (Plotter), AIS and Steering, AIS and Highway, and Highway screens.
- 7 NAVIGATION KEY [NAV]** (p. 28)  
Push to start or stop the Navigation mode.
- 8 WAYPOINT/MAN OVERBOARD KEY [WPT/MOB]**

  - Push to set a waypoint. (p. 24)
  - Hold down for 1 second to start or stop the MOB (Man Overboard) mode. (p. 27)
- 9 POWER KEY [⏻]** (p. 9)  
Hold down for 1 second to turn the transponder ON or OFF.

## 2 PANEL DESCRIPTION

### ■ Function display

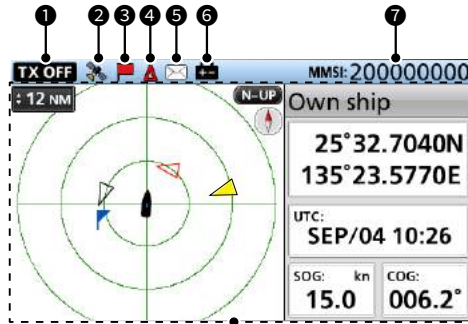

Main screen (p. 11)

#### ❶ TX OFF INDICATOR

Displayed when the TX function is OFF.  
(p. 21)

**NOTE:** When one of the following messages is displayed on the Function display, push [CLR] to clear it.

- “Priority interrupted last attempts.” is displayed when the transponder cannot make a periodic transmission because the transponder detects a transmit signal.

- “Coast Station inhibiting AIS TX. XX min” is displayed when transmission is inhibited by a coast station for the displayed period of time.

- ❶ The transmission inhibit period of time is displayed instead of “XX.” This indicator is displayed while transmission is inhibited.

#### ❷ GPS ICON

- Displayed when GPS data is received.
- Blinks while searching GPS data.  
(p. 9)

#### ❸ NAVIGATION ICON

Displayed during navigation. (p. 28)

- ❶  is displayed while in the MOB mode. (p. 27)

#### ❹ CPA/TPA ICON

Displayed while the CPA/TPA alarm sounds.

#### ❺ MESSAGE ICON

Displayed when there is an unread message. (p. 23)

#### ❻ LOW BATTERY ICON

Displayed when the battery voltage drops to 9 V for 1 second.

- ❶ The icon disappears when the battery voltage returns to 10 V.

#### ❼ MMSI

Displays the 9-digit MMSI code. (p. 4)

- ❶ If a code is not entered, “000000000” is displayed.

## ■ Entering the MMSI code

The Maritime Mobile Service Identity (MMSI: DSC self ID) code consists of 9 digits.

**This initial code can be entered only once.**

After entering, it can be changed only by your dealer or distributor.

If your MMSI code has already been entered, doing the steps below is not necessary.

1. Hold down [⏻] for 1 second to turn ON the transponder.
  - When the language that you use is not set, the “LANGUAGE” screen is displayed. (p. 36)
    - ① Push [CLR] to skip the setting. If the language is not set, the transponder displays in English.
  - Three short beeps sound, and “Push [ENT] to register your MMSI. You can enter between 200000000 and 799999999.” is displayed.
2. Push [ENT] to start entering the MMSI code.
  - The “MMSI INPUT” screen is displayed.
    - ① Push [CLR] three times to skip the entry. If you skip the entry, the transponder operates as just an AIS receiver. After skipping, you can also enter the code in “MMSI” on the Menu screen. (p. 6)

[MENU] > AIS settings > Own ship data > **MMSI**

3. Enter the MMSI code.

**NOTE:** Enter your MMSI code between 200000000 and 799999999. If you enter a code out of this range, an error message is displayed after pushing [ENT] in step 5.

**TIP:**

- Select a number using [◀] and [▶].
- Push [ENT] to enter the selected number.
- Select “←” or “→” on the screen to move the cursor.

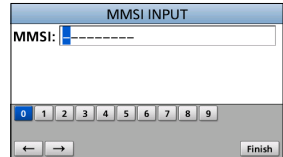

4. Repeat step 3 to enter all 9 digits.
5. Select [Finish] and push [ENT] to set the ID.
  - The “MMSI CONFIRMATION” screen is displayed.
6. Enter the MMSI code again to confirm.
  - When a different code is entered from the “MMSI INPUT” screen, “MMSI does not match.” is displayed, and returns to step 1. Enter a code again in step 1.
7. Select [Finish] and push [ENT] to set the entered code.
  - When your MMSI code is successfully entered, “MMSI registered successfully.” is briefly displayed, and then enters the “OWN SHIP DATA” screen. See the next page for details.
    - ① The “OWN SHIP DATA” screen can also be entered from the Menu screen. (p. 7)

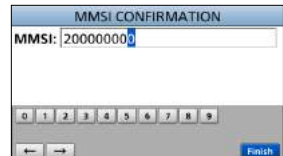

## 3 PREPARATION

### ■ Entering Own ship data

Your vessel's information is exchanged among vessels and/or base stations.

**NOTE:** After entering the MMSI code, the transponder automatically enters the "OWN SHIP DATA" screen. In this case, skip steps 1 ~ 3.

1. Push [MENU].
  - The Menu screen is displayed.
2. Push [▲] or [▼] to select "AIS settings," and then push [ENT].
  - The "AIS SETTINGS" screen is displayed.
  - ① Holding down [▲] or [▼] sequentially scrolls up or down through the Menu screen.



3. Push [▲] or [▼] to select "Own ship data," and then push [ENT].
  - The "OWN SHIP DATA" screen is displayed.

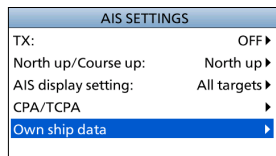

4. Push [▲] or [▼] to select an item.
  - ① See the next page for details.

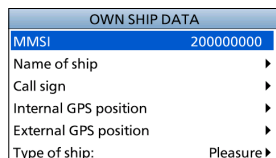

5. Push [▲] or [▼] to select or enter an option or value, and then push [ENT].
  - The transponder returns to the previous screen.

**TIP:**

- Select a number, character, or space using [▲], [▼], [◀], and [▶].
- Push [ENT] to enter the selected number or character.
- Select "←" or "→" on the screen to move the cursor.

6. Repeat steps 4 and 5 to set other items.
7. When the transponder automatically enters the "OWN SHIP DATA" screen after entering the MMSI code, push [CLR] to finish entering Own ship data.
  - "Your information entry finished." is displayed.

## ◇ Own ship data items

### MMSI

Enter the vessel's MMSI code.

- ① See page 4 for details.
- ① If the MMSI code has already been set, you cannot change it.

### Name of ship

Enter the vessel's name of up to 20 characters.

### Call sign

Enter the Call sign of up to 7 characters. The Call sign is a unique designation ID for a station.

### Internal/External GPS position

Set these measurements to indicate the internal and/or external GPS antenna position on the vessel.

The internal GPS antenna is the GPS antenna that is connected to the GPS antenna connector. (p. 40)

The external GPS antenna is the GPS antenna that is connected to the NMEA lines of the external GPS. (p. 41)

- ① The external GPS antenna must be installed within 26 m (85.3 ft) from the internal GPS antenna. Otherwise, the external GPS antenna cannot be used.

- **A: Bow to Antenna/**

- **B: Stern to Antenna**

- Enter between 0 and 511 m (in 1 m steps).

- **C: Port side to Antenna/**

- **D: Starboard side to Antenna**

- Enter between 0 and 63 m (in 1 m steps).

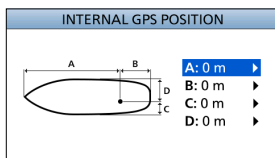

### Type of ship

Select your vessel type.

- ① The selectable ship types may differ, depending on the presetting.

### The type of ship list (Example)

30	Fishing
31	Towing
32	Towing tow>200m / width>25m
33	Engaged in dredging operations
34	Engaged in diving operations
35	Engaged in military operations
36	Sailing
37	Pleasure craft
50	Pilot vessel
51	Search and rescue vessels
52	Tugs
53	Port tenders
54	Vessels with anti-pollution
55	Law enforcement vessels
58	Medical transports
59	Not parties to an armed conflict
60	Passenger - All ships of this type
70	Cargo - All ships of this type
80	Tanker - All ships of this type
90	Other - All ships of this type

# 4

## MENU SCREEN

The Menu screen is used to set items, select options, and so on for the transponder's functions. See page 33 for the Menu items description.

### ■ Menu construction

The Menu screen is constructed in a tree structure.

You can go to the next tree level by pushing [ENT], or [▶], and go back a level by pushing [CLR], or [◀]. See the next page for details.

- ① The displayed menu items may differ, depending on the presetting.

To select an item, push [▲] or [▼].

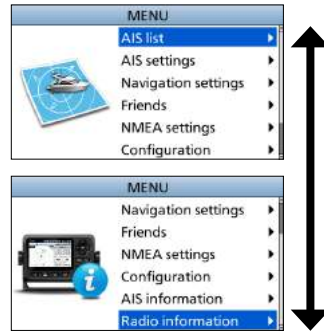

AIS list
Target list
Danger list
Friends list

AIS settings
TX
North up/Course up
AIS display setting
CPA/TCPA
• Alarm
• CPA
• TCPA
• Slow warn
• ID blocking
Own ship data
• MMSI
• Name of ship
• Call sign
• Internal GPS position
• External GPS position
• Type of ship

Navigation settings
Waypoint
Reset navigation
Track
• Display
• Record
• Clear track
• Record reference
• Interval (Distance)
• Interval (Time)
Anchor watch
• Function
• Range
Arrival alarm range
XTE alarm range

Friends
Friends list
Friends alarm

NMEA settings
NMEA 0183
• AIS out
• External GPS in
• NMEA in/out
NMEA 2000
• GPS

Configuration
Backlight
Key beep
Audible alarm
• CPA/TCPA
• Received message
• Arrival
• XTE
• Others
Internal GPS SBAS
Unit
Language

AIS information
Own ship
AIS messages
• RX log
Status
Status log

Radio information
-------------------



## ■ Selecting a Menu item

Follow the procedures described below to select a Menu item.

**Example:** Setting the key beep to “OFF.”

1. Push [MENU].
  - The Menu screen is displayed.
2. Push [▲] or [▼] to select “Configuration,” and then push [ENT].
  - The “CONFIGURATION” screen is displayed.
  - ① Holding down [▲] or [▼] sequentially scrolls up or down through the Menu screen.
3. Push [▲] or [▼] to select “Key beep,” and then push [ENT].
  - The “KEY BEEP” screen is displayed.
4. Push [▲] or [▼] to select “OFF,” and then push [ENT].
  - “OFF” is set, and the transponder returns to the previous screen.

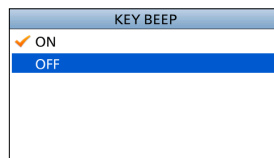
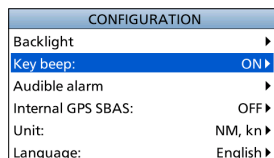
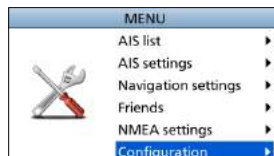

### TIP:

- To exit the Menu screen, push [MENU].
- To return to the previous screen, push [CLR].

## ■ Turning ON the transponder

**IMPORTANT: BE SURE** to connect a GPS antenna or receiver and a marine VHF antenna to the transponder before turning ON the transponder. (p. 40)

- Hold down [⏻] for 1 second to turn ON the transponder.
  - The opening screen is displayed.
- The result of the self check (ROM, RAM, and backup data test) is displayed on the opening screen, “OK” or “failed” (No Good).
  - If “failed” is displayed, hold down [⏻] for 1 second to turn OFF the power, and then turn it ON again. If there is no change, contact your dealer.
  - When the language that you use is not set, the “LANGUAGE” screen is displayed. (p. 36)
    - Push [CLR] to skip the setting. If the language is not set, the transponder displays in English.
  - When no MMSI is set, three beeps sound, and “Push [ENT] to register your MMSI. You can enter between 200000000 and 799999999.” is displayed. (p. 4)
- After the self check is completed, the “Searching GPS” screen is displayed while searching for a GPS satellite.
  - While searching, you can enter the Menu screen by pushing [MENU]. (p. 7)
- When GPS data is received, it is automatically displayed on the plotter screen.



## ■ Backlight function

The Function display and keys can be backlit for better visibility under low light conditions. And, you can set the Backlight mode to Day mode or Night mode.

The Day mode is for the daytime operation, and the screen items are in full color.

The Night mode is for the nighttime operation, and the screen items are in black and red.

1. Open the "Backlight" screen.

[MENU] > Configuration > **Backlight**

2. Push [▲] or [▼] to select "Day mode" or "Night mode."

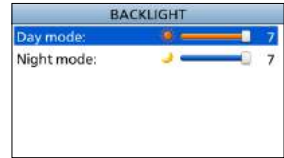

3. Push [◀] or [▶] to adjust the backlight level, and then push [ENT].

- The backlight level is set, and the transponder returns to the previous screen.

- ① The backlight level is adjustable in 7 levels and "OFF." "OFF" is selectable only for the Day mode.

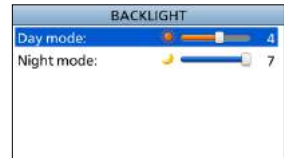

## 5 BASIC OPERATION

### ■ Using the Main screen

There are 4 types of Main screens, AIS, AIS and Steering, AIS and Highway, and Highway screen (only for watching).

In the AIS screen, the display range, the icons of the AIS target or waypoint, and GPS data are displayed. You can change the display range and type, depending on your operating style.

1. Push [DISP] several times to select the AIS screen.
2. Push [▲] or [▼] to select the desired display range.
  - “Calculating” is displayed.
  - ① See “DISPLAY RANGE” on page 12 for the selectable display range.
3. Push [◀] or [▶] to select an AIS target or waypoint.
  - A target box is displayed around the selected target. (p. 13)
  - The selected target’s information is displayed in the information box. (p. 12)
    - ① The contents of the information box may differ, depending on the selected target. (p. 15)
    - ① See “Waypoint” on page 24 for details.

#### TIP:

- Push [▶] to sequentially select each target that is closest to your vessel.
- Push [◀] to sequentially select each target that is farthest from your vessel.

4. Push [ENT] to display the Menu window.
  - The Menu window is displayed.
5. Select “Details,” and then push [ENT] to display the detail screen. (p. 19)
  - The “DETAILS” screen is displayed.

**NOTE:** An alarm sounds when a malfunction occurs, an AIS target is closer than the CPA and TCPA settings, and so on, depending on the presetting. To stop the alarm buzzer, push any key.

- ① If the popup screen is displayed, push any key again to turn it OFF.

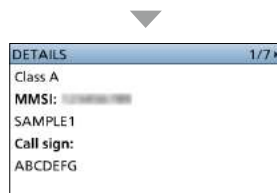

**◇ AIS screen**

Displays the plotter display and selected target's information.

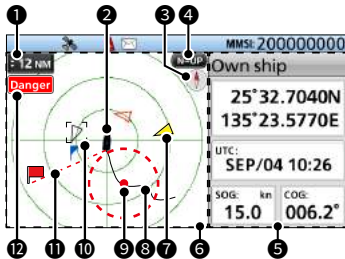

**1 DISPLAY RANGE**

- Displays the selected display range.
  - Push [▲] or [▼] to select the desired display range.
- NM, kn: 0.125, 0.25, 0.5, 0.75, 1.5, 3, 6, 12, 24, 36 NM (nautical miles) are selectable.
- km, km/h: 0.25, 0.5, 1, 1.5, 3, 6, 12, 24, 48, 72 km are selectable.
- ① The selectable display range may differ, depending on the setting of "Unit." (p. 36)

**2 YOUR VESSEL ICON**

- Displayed in the center of the screen.
- ① When "N-UP" is displayed, the vessel icon automatically points in the direction your vessel is heading, in 5.625 degree steps.
  - ① When "C-UP" is displayed, the vessel icon constantly points to the top of the plotter screen.
  - ① When your vessel moves less than 2 knots, ● is displayed.

**3 COMPASS**

Displays the bearing information.

**4 DISPLAY TYPE**

Displays the selected display type. You can select the display type in "North up/Course up" on the Menu screen. (p. 21)

[MENU] > AIS settings > North up/Course up

- ① When "N-UP" is displayed, the top of the plotter screen represents North.
- ① When "C-UP" is displayed, the top of the plotter screen represents the direction your vessel is heading.

**5 INFORMATION BOX**

Displays the selected target's information.

- ① The contents may differ, depending on the selected target. (p. 15)

**6 PLOTTER DISPLAY**

Displays the display range and the icons of the AIS target or waypoint.

**7 TARGET ICON**

Targets whose AIS signal are received are displayed with icons. The icon may differ, depending on the target type or its status.

Icon	Description
	AIS target: Vessel ① The tip of the target triangle automatically points in the direction it's heading.
	AIS target: Vessel (Friend)
	AIS target: AIS-SART, AIS-MOB, and EPIRB-AIS
	AIS target: Search and Rescue (SAR) vessel
	AIS target: Search and Rescue (SAR) aircraft
	AIS target: Aids to Navigation (AtoN)
	AIS target: Aids to Navigation (AtoN) virtual
	AIS target: Base station
	Waypoint ①  is displayed during navigation.
	MOB

- ① Icons for other than the SAR aircraft, Base station, Waypoint, and MOB are displayed in red or white while in the Night mode (pp. 10, 36) when the AIS target is closer than your CPA and TCPA settings (Danger target). (p. 21)
- ① A vessel is regarded as a "Lost target," and a black cross mark displays on the target icon after a specified period of time has passed since the vessel last transmitted data (p. 30). The Lost target icon disappears from the plotter display 6 minutes and 40 seconds after the vessel was regarded as a "Lost target." Ask your dealer for details.

# 5 BASIC OPERATION

## ◇ AIS screen

### ⑧ VESSEL TRACK

Displays your vessel track.

### ⑨ ANCHOR WATCH

- Displays  (a red circle) as the start position of anchor watch.
- Displays a red dashed circle as the range of anchor watch.

### ⑩ TARGET BOX

Displays the selected AIS target.

- ① When a target box is displayed, push [ENT] and select "Details" to display the detail screen of the selected AIS target.



### ⑪ NAVIGATION LINE

Displays a line from the start position of navigation to the AIS target or waypoint.

### ⑫ DISPLAY LIMIT INDICATOR

Displayed when the AIS targets or waypoints that are displayed on the plotter display are limited to the displayed type. (p. 21)

[MENU] > AIS settings >  
**AIS display setting**

Indicator	Description
	Only Danger targets are displayed.
	Only Friend targets are displayed.
	Only waypoints are displayed.
No indicator	All targets are displayed.

## ◇ AIS and Steering screen

Displays the plotter display and steering information.



### ① COMPASS

Displays the direction based on your COG (Course Over Ground).

- ①  is displayed during navigation.

### ② OWN SHIP INDICATOR

Displayed in the center of the compass.

### ③ COG

Displays your COG (Course Over Ground) reading in degrees.

### ④ INFORMATION

Displays the following information.

- ① The contents may differ, depending on the situation.
  - SOG (Speed Over Ground)
  - COG (Course Over Ground)
  - Position (Latitude, Longitude)
  - BRG (Bearing)
  - RNG (Range)
  - XTE (Cross Track Error)

◇ **AIS and Highway screen**

Displays the plotter display and highway information.



**1 HIGHWAY**

Displayed during navigation.

① "Navigation OFF" is displayed on the Highway screen when the Navigation mode is not used.

① See "Highway screen" for details.

**2 INFORMATION**

Displays the following information.

- RNG (Range)
- XTE (Cross Track Error)
- SOG (Speed Over Ground)
- COG (Course Over Ground)

◇ **Highway screen**

Displays the highway information.

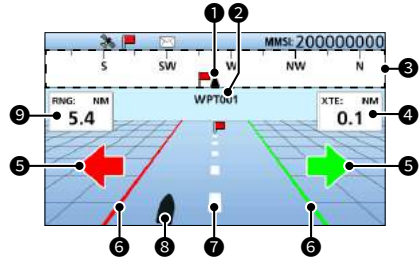

**1 OWN SHIP INDICATOR**

Displayed in the center of the compass.

**2 WAYPOINT NAME**

Displays the waypoint's name.

① "AIS target" is displayed when navigating to the AIS target.

① "MOB" is displayed while in the MOB mode. (p. 27)

① "Navigation OFF" is displayed when the Navigation mode is not used.

**3 COMPASS**

Displays the direction based on your COG (Course Over Ground).

**4 XTE**

Displays the Cross Track Error.

**5 STEERING DIRECTION**

Displayed when the vessel crosses the XTE (Cross Track Error) limit line.

**6 XTE LIMIT LINE**

Displays the limit line that marks when the vessel goes off course.

**7 NAVIGATION LINE**

Displays a line from the start position of navigation to the AIS target or waypoint.

**8 YOUR VESSEL ICON**

Displayed according to the destination's position.

① When your vessel moves less than 2 knots, ● is displayed.

**9 RNG**

Displays the range (RNG) from your vessel to the target.

## 5 BASIC OPERATION

### ◇ About the information box

The information box displays the information about the selected AIS target or waypoint. The contents may differ, depending on the selected target.

- Push [◀] or [▶] to select an AIS target or waypoint on the AIS screen.
  - The selected target's information is displayed on the right side of the AIS screen.
  - When a Danger target is selected, ▲ is displayed. (p. 17)
  - When a Friend target is selected, ★ is displayed. (p. 17)
- ① The information about MOB is displayed while in the MOB mode.

35°45.3280N	
135°35.7798E	
CPA: NM	TCPA: min
0.3	0
SOG: kn	COG:
18.6	081.2°

Own ship
Position (Latitude, Longitude)
UTC
SOG (Speed Over Ground)
COG (Course Over Ground)

Class A, Class B, AIS-SART, AIS-MOB EPIRB-AIS, and SAR vessel
MMSI code or name
Position (Latitude, Longitude)
CPA (Closest Point of Approach)
TCPA (Time to CPA)
SOG (Speed Over Ground)
COG (Course Over Ground)

Base station
MMSI code
Position (Latitude, Longitude)
RNG (Range)
BRG (Bearing)

SAR aircraft
MMSI code
Position (Latitude, Longitude)
SOG (Speed Over Ground)
COG (Course Over Ground)
ALT (Altitude)

AtoN and AtoN virtual
MMSI code or name
Position (Latitude, Longitude)
CPA (Closest Point of Approach)
TCPA (Time to CPA)
RNG (Range)
BRG (Bearing)

Waypoint
Name
Position (Latitude, Longitude)
RNG (Range)
BRG (Bearing)

MOB
Position (Latitude, Longitude)
RNG (Range)
BRG (Bearing)



## ■ Using the AIS list screen

There are 3 types of AIS lists, Target, Danger, and Friends.  
The target's information is automatically updated every 5 seconds, and then the AIS target data is sorted.

1. Push [MENU].
  - The Menu screen is displayed.
2. Push [▲] or [▼] to select "AIS list," and then push [ENT].
  - The "AIS LIST" screen is displayed.
3. Push [▲] or [▼] to select a list, and then push [ENT].
  - The list screen is displayed.
4. Push [▲] or [▼] to select an AIS target.
5. Push [ENT] to display the Menu window.
  - The Menu window is displayed.
6. Select "Details," and then push [ENT] to display the detail screen. (p. 19)
  - The "DETAILS" screen is displayed.

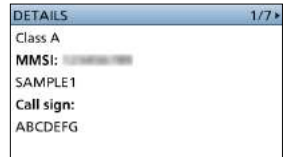
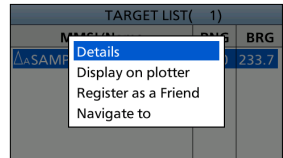
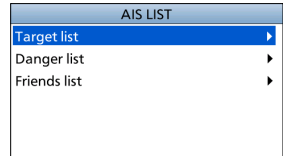

**NOTE:** An alarm sounds when a malfunction occurs, an AIS target is closer than the CPA and TCPA settings, and so on, depending on the presetting. To stop the alarm buzzer, push any key.

① If the popup screen is displayed, push any key again to turn it OFF.

**TIP:** The selected target in the list can be displayed on the plotter display.

1. Repeat steps 1 ~ 5.
2. Select "Display on plotter," and then push [ENT].
  - The plotter display is displayed, and a target box is displayed around the selected target. (p. 13)
  - When the selected target is out of range, a popup screen is displayed.

# 5 BASIC OPERATION

## ◇ Target/Friends list screen

The Target list screen displays all AIS targets that the transponder detects.

The Friends list screen displays the AIS targets that you set as a Friend, and that the transponder detects. (p. 18)

The AIS target data is sorted by the distance from your vessel, and the closest target is located at the top of the list.

MMSI/Name	RNG	BRG
ΔSAMPLE2	4.2	020.2
ΔSAMPLE1	4.8	287.6
ΔSAMPLE3	6.9	082.3

MMSI/Name	RNG	BRG
ΔSAMPLE3	6.9	082.3

- ❶ **THE NUMBER OF TARGETS**  
Displays the number of AIS targets that the transponder detects.
- ❷ **TARGET INFORMATION**  
Displays the following AIS target information.
  - Target icon
    - ❶ “A” or “B” is also displayed next to Δ, depending on the vessel class.
  - MMSI code or name
    - ❶ When a Friend is detected, ★ is displayed on the Target list.
  - Range (RNG) from your vessel to the target (unit: NM or km)
  - Bearing (BRG) from your vessel to the target (unit: degree)

## ◇ Danger list screen

The Danger list screen displays any Danger target whose CPA (Closest Point of Approach) distance and TCPA (Time to CPA) time are less than the set values. You can set the values in “CPA” and “TCPA” on the Menu screen. (p. 21)

[MENU] > AIS settings > CPA/TCPA > CPA/TCPA

The Danger target data is sorted by CPA or TCPA.

- Push [◀] to sort the AIS target data by CPA.
- Push [▶] to sort the AIS target data by TCPA.

MMSI/Name	CPA	TCPA
ΔSAMPLE2	1.1	16

- ❶ **THE NUMBER OF TARGETS**  
Displays the number of AIS targets that the transponder detects.
- ❷ **DANGER TARGET INFORMATION**  
Displays the following AIS target information.
  - Target icon
    - ❶ “A” or “B” is also displayed next to Δ, depending on the vessel class.
  - MMSI code or name
    - ❶ When a Friend is detected, ★ is displayed on the Danger list.
  - CPA: Closest Point of Approach (unit: NM or km)
  - TCPA: Time to CPA (unit: minute)

## ■ Setting a Friend

You can set up to 100 AIS targets as a Friend in the Friends list.

An alarm sounds when a Friend is detected, depending on the setting. (p. 34)

### ◇ Entering an ID

There are 3 ways of setting a Friend, using the Friends list, selecting in the AIS list, or selecting on the plotter display.

#### Using the Friends list:

1. Open the "Friends list" screen.

[MENU] > Friends > **Friends list**

- "No ID" is displayed when there is no Friend.
2. Push [ENT] to display the Menu window.
    - The Menu window is displayed.
  3. Select "Add" and push [ENT] to start the ID entry.
  4. Select "Finish" and push [ENT] to enter the ID.

#### Selecting in the AIS list:

1. Open an AIS list screen.

[MENU] > AIS list > **Target list/Danger list**

2. Push [▲] or [▼] to select an AIS target.
3. Push [ENT] to display the Menu window.
  - The Menu window is displayed.
4. Select "Register as a Friend," and push [ENT].
  - ★ is displayed.

#### Selecting on the plotter display:

1. Push [◀] or [▶] to select an AIS target.
  - A target box is displayed around the selected target. (p. 13)
2. Push [ENT] to display the Menu window.
  - The Menu window is displayed.
3. Select "Register as a Friend," and push [ENT].
  - ▲ is displayed on the plotter display.
  - ★ is displayed in the information box.

### ◇ Deleting an ID

1. Open the "Friends list" screen.

[MENU] > Friends > **Friends list**

2. Select an ID, and push [ENT] to display the Menu window.
  - The Menu window is displayed.
3. Select "Delete," and push [ENT].
  - "Delete friend ID. Are you sure?" is displayed.
4. Select "OK," and push [ENT].

## 5 BASIC OPERATION

### ■ About the detail screen

The detail screen displays the information about the selected AIS target or waypoint. The contents may differ, depending on the selected target.

- ① When a Danger target is selected, ▲ is displayed. (p. 17)
- ① When a Friend target is selected, ★ is displayed. (p. 17)

<b>Class A and SAR vessel</b>
AIS class
MMSI code
Ship name
Country name
Call sign
IMO number
CPA (Closest Point of Approach)
TCPA (Time to CPA)
Position (Latitude, Longitude)
SOG (Speed Over Ground)
COG (Course Over Ground)
HDG (Heading)
PA (Position Accuracy (H: High, L: Low))
Range
Bearing
ROT (Rate Of Turn)
Bow to antenna length
Stern to antenna length
Port side to antenna length
Starboard side to antenna length
Length
Beam
Draught
Type of ship
Navigation status
Destination
Estimated time of arrival
Elapsed time

<b>Class B</b>
AIS class
MMSI code
Ship name
Country name
Call sign
Vendor ID (p. 20)
CPA (Closest Point of Approach)
TCPA (Time to CPA)

Position (Latitude, Longitude)
SOG (Speed Over Ground)
COG (Course Over Ground)
HDG (Heading)
PA (Position Accuracy (H: High, L: Low))
Range
Bearing
Bow to antenna length
Stern to antenna length
Port side to antenna length
Starboard side to antenna length
Length
Beam
Type of ship
Elapsed time

<b>AIS-SART, AIS-MOB, and EPIRB-AIS</b>
AIS class
MMSI code
CPA (Closest Point of Approach)
TCPA (Time to CPA)
Position (Latitude, Longitude)
SOG (Speed Over Ground)
COG (Course Over Ground)
HDG (Heading)
PA (Position Accuracy (H: High, L: Low))
Range
Bearing
ROT (Rate Of Turn)
Elapsed time

<b>Base station</b>
AIS class
MMSI code
Position (Latitude, Longitude)
PA (Position Accuracy (H: High, L: Low))
Range
Bearing
Elapsed time

<b>SAR aircraft</b>
AIS class
MMSI code
Target name
Country name
Call sign
Position (Latitude, Longitude)
SOG (Speed Over Ground)
COG (Course Over Ground)
ALT (Altitude)
PA (Position Accuracy (H: High, L: Low))
Range
Bearing
Length
Beam
Elapsed time

<b>AtoN and AtoN virtual</b>
AIS class
MMSI code
Target name
CPA (Closest Point of Approach)
TCPA (Time to CPA)
Position (Latitude, Longitude)
PA (Position Accuracy (H: High, L: Low))
Position indicator (ON POSN: ON Position, OFF POSN: OFF Position)
Range
Bearing
Bow to antenna length
Stern to antenna length
Port side to antenna length
Starboard side to antenna length
Length
Beam
Type of AtoN (p. 49)
Elapsed time

<b>Waypoint</b>
Name
Position (Latitude, Longitude)
Range
Bearing

**NOTE:**

**Vendor ID information**

The serial number of this Icom product has eight digits. The first two digits indicate the version number. The last six digits indicate its unique number.

**Example**

The serial number is “13000001.”  
 The first two digits: Version number (13)  
 The last six digits: Unique number (000001)

This MA-510TR displays a three part vendor ID separated by a slash (/). The first part is fixed at “ICO” (ICOM). The second part is the generation number for the AIS transponder under Icom products. It is fixed at “02,” and means the MA-510TR.

The third part has eight digits and indicates the version number and its unique number, as follows:

**Vendor ID:**

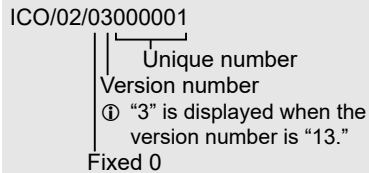

---

## 5 BASIC OPERATION

### ■ AIS settings

AIS settings can be customized in “AIS settings” on the Menu screen.

---

#### TX

Turn the TX function ON or OFF.

**WARNING:** If this setting is “OFF,” AIS data is not transmitted. Therefore, your vessel will not be visible to other vessels, and this could result in a collision.

ON: AIS data is transmitted.

OFF: AIS data is not transmitted.

---

#### North up/Course up

You can select the display type for the AIS plotter screen.

North up: The top of the plotter screen represents North.

Course up: The top of the plotter screen represents the direction your vessel’s course over ground.

---

#### AIS display setting

You can select whether or not to limit the AIS or waypoint targets that are displayed on the plotter display. You can easily see the plotter display.

① The indicator is displayed on the plotter display. (p. 13)

① The waypoint for navigation is displayed, regardless of this setting.

All targets: All targets are displayed.

Danger only: Only Danger targets are displayed.

Friends only: Only Friend targets are displayed.

Waypoint only: Only waypoints are displayed.

---

#### CPA/TCPA

##### ● Alarm

You can select whether or not to turn the following alarm functions ON or OFF.

##### • CPA/TCPA alarm function:

The alarm for when a vessel’s CPA is closer, and TCPA is less than the set value.

##### • Danger target lost alarm function:

The alarm for when a danger target is regarded as a “Lost target.” (p. 30)

ON: The alarm functions are ON.

An alarm sounds, and a popup screen is displayed.

① The alarm may not sound, depending on the setting. (p. 36)

OFF: The alarm functions are OFF.

##### ● CPA

Set a CPA (Closest Point of Approach) value between 0.01 and 6.00 NM (in 0.01 NM steps), or between 0.02 and 11.11 km (in 0.01 km steps), for the alarm function.

##### ● TCPA

Set a TCPA (Time to CPA) value between 1 and 60 minutes (in 1 minute steps) for the alarm function.

**■ AIS settings****CPA/TCPA****● Slow warn**

The GPS receiver calculated COG data of a vessel that is at anchor or drifting is unreliable, and therefore the CPA and TCPA data may not be calculated correctly. If a vessel is anchored in your alarm zone, the unreliable data can cause the collision alarm to sound many times, even if there is no real danger. To prevent this, when the anchored vessel's SOG is less than this set value, the Slow Warn function assumes that vessel's COG is fixed towards your vessel and an alarm will sound.

**• Function**

Turn the Slow warn function ON or OFF.  
ON: The Slow warn function is turned ON.

OFF: The Slow warn function is turned OFF.

**• Speed**

Set a speed for the Slow warn function between 0.1 and 4.9 kn (in 0.1 kn steps), or between 0.2 and 9.1 km (in 0.1 km steps).

**NOTE:** If other vessels at anchor or drifting come into your alarm zone, the Slow warn alarm will sound again. Only if the previous vessel disappears from the Danger list (p. 17), and then re-enters the list, can a new Slow warn or regular alarm sound, depending on the vessel's SOG, or CPA and TCPA. The Slow warn function operates in the same way if your vessel is at anchor and other vessels enter your alarm zone.

**CPA/TCPA****● ID blocking**

Enter an MMSI (Maritime Mobile Service Identity) code not to sound a collision alarm. The alarm does not sound if a vessel that is entered into the ID blocking list is closer than the set CPA/TCPA values.

① You can enter up to 10 MMSI codes.

**• Entering an ID**

1. Open the "ID blocking" screen.

[MENU] > AIS Settings >  
CPA/TCPA > **ID blocking**

- The blocked AIS transponder's ID is displayed.
- "No ID" is displayed if there is no blocked AIS transponder.

2. Push [ENT] to display the Menu window.

- The Menu window is displayed.

3. Select "Add," and then push [ENT] to start the ID entry.

4. Select "Finish," and then push [ENT] to enter the ID.

**• Deleting an ID**

1. Open the "ID blocking" screen.

[MENU] > AIS Settings >  
CPA/TCPA > **ID blocking**

2. Select an ID, and then push [ENT] to display the Menu window.

- The Menu window is displayed.

3. Select "Delete," and then push [ENT].

- "Delete ID blocking. Are you sure?" is displayed.

4. Select "OK," and then push [ENT].

**Own ship data**

Set your vessel's information.

① See page 6 for details.

## ■ Message

### ◇ Receiving a message

A safety-related message of up to 161 characters can be received from an AIS equipped vessel in the area.

- When a message is received, a beep sounds, and a popup screen is displayed.
  - “Message is received. Read it now?” is displayed.
- Select [OK], and then push [ENT] to display the message.
  - The “DETAILS” screen is displayed.

**NOTE:** The received messages are automatically saved in your RX log. See below for details.





### ◇ Message logs

The transponder saves up to 20 received messages in your RX log. The oldest message is automatically deleted when a new message is received. On the Function display,  is displayed when there is an unread message.

- Open the “RX log” screen.

[MENU] > AIS Information > AIS messages > **RX log**

- “No message” is displayed when there is no received message.
  -  is displayed when there is an unread message.
  -  is displayed when there is no unread message.
- Push [▲] or [▼] to select a message, and then push [ENT] to display the detail message.
    - The “DETAILS” screen is displayed.

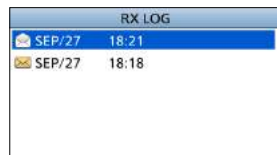



## Waypoint

### Waypoint list

The transponder saves up to 100 waypoints in the waypoint list.

1. Open the “Waypoint” screen.

[MENU] > Navigation settings > **Waypoint**

2. Push [▲] or [▼] to select a waypoint.

① Push [◀] to sort the waypoint data by Name.

① Push [▶] to sort the waypoint data by Range.

① A waypoint during navigation is located at the top of the list, and  is displayed.

WAYPOINT		
Name	RNG	BRG
WPT001	0.00	245.3
WPT002	0.00	245.3
WPT003	0.00	231.0

3. Push [ENT] to display the Menu window.

• The Menu window is displayed.

4. Select “Details,” and then push [ENT] to display the detail screen.

• The “DETAILS” screen is displayed.

WAYPOINT		
Name	RNG	BRG
WPT001	0.00	262.3
WPT002	0.00	262.3
WPT003	0.00	284.4

Details  
 Navigate to  
 Edit  
 Delete  
 Add

DETAILS	
Name:	WPT001
LAT:	34°37.3879N
LOn:	135°34.2921E
Range:	0.00 NM
Bearing:	000.0°

### Navigating to a waypoint

The transponder assists you to navigate to a selected waypoint in the Waypoint list.

① See “Navigation” on page 28 for details.

1. Open the “Waypoint” screen.

[MENU] > Navigation settings > **Waypoint**

2. Push [▲] or [▼] to select a waypoint.

① Push [◀] to sort the waypoint data by Name.

① Push [▶] to sort the waypoint data by Range.

3. Push [ENT] to display the Menu window.

• The Menu window is displayed.

4. Select “Navigate to,” and then push [ENT].

• “Start navigation. Are you sure?” is displayed.

WAYPOINT		
Name	RNG	BRG
WPT001	0.00	265.7
WPT002	0.00	265.7
WPT003	0.00	045.8

Details  
 Navigate to  
 Edit  
 Delete  
 Add

5. Select “OK,” and then push [ENT] to start navigation.

• The AIS and Highway screen is displayed, and the transponder starts to navigate.

## 6 OTHER FUNCTIONS

### ◇ Entering a waypoint

The position information that you want to memorize can be added as a waypoint.

**NOTE:** You can also add your current position as a waypoint by pushing [WPT/MOB].

1. Open the “Waypoint” screen.

[MENU] > Navigation settings > **Waypoint**

2. Push [ENT] to display the Menu window.
  - The Menu window is displayed.
3. Select “Add,” and then push [ENT] to add a waypoint.
  - The “Name:” screen is displayed.
  - ① If the waypoint memory is full, a popup screen is displayed.

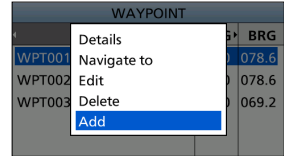

4. Enter a name.

**TIP:**

- Select a number, character, or space using [▲], [▼], [◀], and [▶].
- Push [ENT] to enter the selected number or character.
- Select “←” or “→” on the screen to move the cursor.

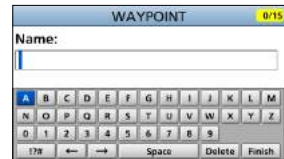

5. Repeat step 4 to enter the name of up to 15 characters.
6. Select [Finish], and then push [ENT] to set the name.
  - The “LAT:” screen is displayed.
  - ① If you enter no name, a popup screen is displayed, and push any key to return the previous screen.
7. Enter a latitude.
  - ① When GPS data is received, your current position information is automatically displayed.

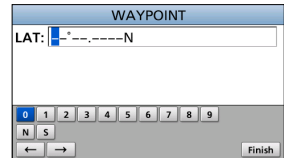

8. Select [Finish], and then push [ENT] to set the latitude.
  - The “LON:” screen is displayed.
  - ① If you enter the latitude out of range, a popup screen is displayed, and push any key to return the previous screen.
9. Enter a longitude.
  - ① When GPS data is received, your current position information is automatically displayed.

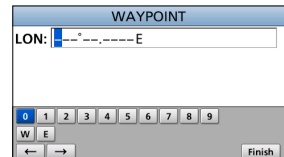

10. Select [Finish], and then push [ENT] to set the longitude.
  - The waypoint is set, and the transponder returns to the previous screen.
  - ① If you enter the longitude out of range, a popup screen is displayed, and push any key to return the previous screen.

## ◇ Editing a waypoint

A waypoint's name, latitude, longitude data can be edited.

1. Open the "Waypoint" screen.

[MENU] > Navigation settings > **Waypoint**

2. Push [▲] or [▼] to select a waypoint.
  - ① Push [◀] to sort the waypoint data by Name.
  - ① Push [▶] to sort the waypoint data by Range.
3. Push [ENT] to display the Menu window.
  - The Menu window is displayed.
4. Select "Edit," and then push [ENT].
  - ① See steps 4 ~ 10 steps in "Entering a waypoint" on page 25.

WAYPOINT		
	Details	BRG
WPT001	Navigate to	350.7
WPT002	<b>Edit</b>	350.7
WPT003	Delete	055.8
	Add	

6

## ◇ Deleting a waypoint

A waypoint can be deleted from the Waypoint list.

1. Open the "Waypoint" screen.

[MENU] > Navigation settings > **Waypoint**

2. Push [▲] or [▼] to select a waypoint.
  - ① Push [◀] to sort the waypoint data by Name.
  - ① Push [▶] to sort the waypoint data by Range.
3. Push [ENT] to display the Menu window.
  - The Menu window is displayed.
4. Select "Delete," and then push [ENT].
  - "Delete waypoint. Are you sure?" is displayed.
5. Select "OK," and then push [ENT].
  - The selected target is deleted, and the transponder returns to the previous screen.

WAYPOINT		
	Details	BRG
WPT001	Navigate to	079.7
WPT002	Edit	079.7
WPT003	<b>Delete</b>	072.4
	Add	

## 6 OTHER FUNCTIONS

### ■ MOB (Man Overboard)

The transponder assists you in rescuing a man who has fallen overboard.

- ① The function works only when the transponder is receiving valid GPS signals.
- ① The transponder automatically exits the Navigation mode if it is in that mode.

#### ◇ Starting MOB

- Hold down [WPT/MOB] for 1 second to start the MOB mode.
  - The AIS screen is displayed, and  is displayed in your current position on the plotter display.
  - The information about MOB is displayed in the information box.
- ① The Arrival and XTE alarms are not detected while in the MOB mode.



The red dashed line is displayed between your vessel icon and the MOB icon.

#### ◇ Stopping MOB

1. Hold down [WPT/MOB] for 1 second, or push [CLR] to stop the MOB mode.
  - “Deactivate MOB. Are you sure?” is displayed.
2. Select “OK,” and then push [ENT].
  -  disappears, and the transponder returns to the previous screen.



## Navigation

The transponder assists you to navigate to a selected destination.

- ① The function works only when the transponder is receiving valid GPS signals.
- ① The function cannot work while in the MOB mode.

**NOTE:** MA-510TR's Navigation function is a supplemental aid to navigation only, and is not intended to be a substitute for primary Navigation equipment.

### ◇ Starting navigation

There are 4 ways of setting a destination, using [NAV], selecting in the AIS list, selecting in the Waypoint list, and selecting on the plotter display.

#### Using [NAV]:

1. Push [NAV].
  - The "WAYPOINT" screen is displayed.
2. Push [▲] or [▼] to select a waypoint.
  - ① Push [◀] to sort the waypoint data by Name.
  - ① Push [▶] to sort the waypoint data by Range.

WAYPOINT		
Name	RNG	BRG
WPT001	0.6	180.0
WPT002	0.1	180.0

3. Push [ENT] to start navigation.
  - The AIS and Highway screen is displayed, and the transponder starts to navigate.



#### Selecting in the AIS list:

1. Open the list screen.
  - [MENU] > AIS list > **Target/Danger/Friend list**
2. Push [▲] or [▼] to select an AIS target.
3. Push [ENT] to display the Menu window.
  - The Menu window is displayed.
4. Select "Navigate to," and then push [ENT] to start navigation.
  - The AIS and Highway screen is displayed, and the transponder starts to navigate.

#### Selecting in the Waypoint list:

See "Navigating to a waypoint" on page 24 for details.

## 6 OTHER FUNCTIONS

### Selecting on the plotter display:

1. Push [◀] or [▶] to select an AIS target or waypoint.
  - A target box is displayed around the selected target.  
(p. 13)
2. Push [ENT] to display the Menu window.
  - The Menu window is displayed.
3. Select "Navigate to," and then push [ENT].
  - "Start navigation. Are you sure?" is displayed.
4. Select "OK," and then push [ENT] to start navigation.
  - The target's current position is set as a waypoint.
  - The AIS and Highway screen is displayed, and the transponder starts to navigate.



### NOTE:

- An alarm sounds, and a popup screen is displayed when the vessel arrives at or near the destination. To stop the alarm and navigation, push any key.
- An alarm sounds, and a popup screen is displayed when the vessel goes off course.
  - ① When the vessel comes back on course, the alarm automatically stops.
- If the transponder is turned OFF during navigation, the transponder continues navigation.

### ◇ Stopping navigation

1. Push [NAV] to stop navigation.
  - "Stop navigation. Are you sure?" is displayed.
    - ① The transponder can also stop navigation by pushing [CLR] when no target is selected.
2. Select "OK," and then push [ENT].
  - The transponder stops to navigate.



### ◇ Resetting navigation

The transponder resets the start position, and restarts navigation from your current position.

- ① The function works only when the transponder is receiving valid GPS signals.
- ① The function cannot work while in the MOB mode, or when the transponder does not navigate.

1. Open the "Navigation settings" screen.

[MENU] > **Navigation settings**

2. Push "Reset navigation" to reset the start position.
  - The popup screen is displayed.
3. Select "OK," and then push [ENT].
  - The transponder resets the start position, and restarts navigation from your current position.

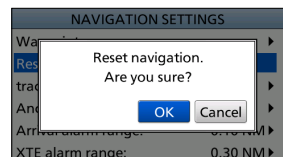

## ■ Lost target

A vessel is regarded as a “Lost target” after a specified period of time has passed since the vessel last transmitted data, as described below.

The “Lost target” icon disappears from the plotter display 6 minutes and 40 seconds after the vessel was regarded as a “Lost target.” Ask your dealer for details.

### The criteria to become a Lost target

#### • Class A/B

Vessel type		Lost target maximum interval Class A	Lost target maximum interval Class B *1	
			CS *2	SO*3
1	Class A: Vessel is at anchor, moored and not moving faster than 3 knots Class B: Vessel is not moving faster than 2 knots	1080 seconds	1080 seconds	
2	Vessel is at anchor, moored and moving faster than 3 knots	60 seconds	N/A	
3	Class A: Vessel is moving between 0 and 14 knots Class B: Vessel is moving between 2 and 14 knots	60 seconds	N/A	180 seconds
4	Class A: Vessel is moving between 0 and 14 knots while changing course Class B: Vessel is moving between 2 and 14 knots while changing course	60 seconds	N/A	
5	Vessel is moving between 14 and 23 knots	36 seconds	N/A	90 seconds
6	Vessel is moving between 14 and 23 knots while changing course	36 seconds	N/A	
7	Vessel is moving faster than 23 knots	30 seconds	N/A	30 seconds
8	Vessel is moving faster than 23 knots while changing course	30 seconds	N/A	
9	Vessel is moving faster than 2 knots	N/A	180 seconds	N/A

\*1 AIS Class B does not provide information about the navigational status, anchored or moored.

\*2 CS: Carrier-sense, \*3 SO: Self organized

#### • Others

Category	Lost target maximum interval
SAR aircraft	60 seconds
AtoN	1080 seconds
Base station	60 seconds

## 6 OTHER FUNCTIONS

### ■ Individual DSC call

(Possible only when a transceiver is connected.)

When a transceiver is connected to the transponder, you can transmit an Individual DSC call without entering the vessel's MMSI code, by simply selecting its AIS target and the voice channel on the transponder. The transceiver will use the transponder's data information and make the DSC call on channel 70, and then wait for the target vessel to acknowledge it. After receiving the acknowledgment 'Able to comply,' use the transceiver to communicate with the target vessel on the predetermined voice channel.

- ① The following transceivers can operate with this function. (As of November 2019)  
IC-M605/IC-M605EURO/IC-M506/IC-M506GE/IC-M424G/IC-M400BB/  
IC-M330/IC-M330GE/IC-M330G/IC-M220
- ① See page 42 for connecting to the transceiver.

**NOTE:** The data communication speed (baud rate) of NMEA1 must be set to 4800 bps to send an Individual DSC call using the transponder.

1. Select an AIS target on the plotter display, Target, Danger, or Friends list screen. (pp. 11, 16)
2. Push [ENT] to display the Menu window.
  - The Menu window is displayed.
3. Select "Send DSC," and then push [ENT].
  - The "DSC TRANSMISSION" screen is displayed.
4. Push [▲] or [▼] to select a voice channel.
  - Voice channels are already preset into the transponder in the recommended order.

**NOTE:** When a base station is selected in step 1, a voice channel will be specified by the base station. Therefore you cannot change the channel. The transponder will display "Voice Channel is specified by the Base station," in this case.

DSC TRANSMISSION	
Select voice channel.	
Channel:	08 ▾
And push [ENT] to transmit.	

5. Push [ENT] to make the Individual DSC call.
  - "Transmitting individual call" is displayed.
  - ① If Channel 70 is busy, the transceiver stands by until the channel becomes clear.
6. After making the Individual DSC call, "DSC transmission completed." is displayed.
  - If the transceiver cannot make the call, "DSC transmission failed." is displayed.
7. Push [CLR] to return to the Main screen.
8. After receiving the acknowledgment from the AIS target, use the transceiver to communicate. See the transceiver's manual for details.



## ■ Menu items

The Menu screen is constructed in a tree structure. (p. 7)  
See the referred pages for each item.

① The displayed menu items may differ, depending on the presetting.

AIS list	
Target list	p. 17
Danger list	
Friends list	

AIS settings	
TX	p. 21
North up/Course up	
AIS display setting	
CPA/TCPA	
• Alarm	p. 22
• CPA	
• TCPA	
• Slow warn	
• ID blocking	p. 6
Own ship data	
• MMSI	
• Name of ship	
• Call sign	
• Internal GPS position	
• External GPS position	
• Type of ship	

Navigation settings	
Waypoint	pp. 24, 33
Reset navigation	pp. 29, 33
Track	p. 33
• Display	
• Record	
• Clear track	
• Record reference	
• Interval (Distance)	
• Interval (Time)	
Anchor watch	
• Function	
• Range	
Arrival alarm range	
XTE alarm range	

Friends	
Friends list	p. 34
Friends alarm	

NMEA settings	
NMEA 0183	p. 34
• AIS out	
• External GPS in	
• NMEA in/out	
NMEA 2000	
• GPS	

Configuration	
Backlight	pp. 10, 36
Key beep	p. 36
Audible alarm	
• CPA/TCPA	
• Received message	
• Arrival	
• XTE	
• Others	
Internal GPS SBAS	
Unit	
Language	

AIS information	
Own ship	p. 36
AIS messages	
• RX log	
Status	p. 37
Status log	

Radio information	
	p. 37

## ■ Menu items description

### ◇ Navigation settings

#### Waypoint

Displays the Waypoint list.

① See page 24 for details.

#### Reset navigation

The transponder resets the start position, and restarts navigation from your current position.

① See page 29 for details.

#### Track

##### ● Display

You can select whether or not to display the vessel track on the plotter display.

① The vessel track is recorded, regardless of this setting.

ON: The vessel track is displayed.

OFF: The vessel track is not displayed.

##### ● Record

You can select whether or not to save the vessel track.

ON: The vessel track is saved.

OFF: The vessel track is not saved.

##### ● Clear track

You can delete the vessel track.

① When "Clear track. Are you sure?" is displayed, select "OK," and then push [ENT].

##### ● Record reference

You can select the setting to record the vessel track.

Distance: The vessel track is recorded for a fixed distance.

Time: The vessel track is recorded for a fixed period of time.

##### ● Interval (Distance)

Set the distance to record the vessel track to between 0.01 and 6.00 NM (in 0.01 NM steps), or between 0.02 and 11.11 km (in 0.01 km steps), when you select "Distance" in the Record reference.

##### ● Interval (Time)

Set the period of time to record the vessel track to between 1 and 60 seconds (in 1 second steps) when you select "Time" in the Record reference.

#### Anchor watch

##### ● Function

You can select whether or not to sound an alarm when your vessel is at anchor, and has drifted.

##### ● Range

Set the range to sound an alarm when your vessel is at anchor, and has drifted to between 0.01 and 6.00 NM (in 0.01 NM steps), or between 0.02 and 11.11 km (in 0.01 km steps).

#### Arrival alarm range

Set the range to sound an alarm when your vessel arrives at or near the destination to between 0.01 and 6.00 NM (in 0.01 NM steps), or between 0.02 and 11.11 km (in 0.01 km steps).

#### XTE alarm range

Set the range to sound an alarm when your vessel goes off course to between 0.01 and 6.00 NM (in 0.01 NM steps), or between 0.02 and 11.11 km (in 0.01 km steps).

## ◇ Friends

### Friends list

Displays all Friend targets that you have entered.

- ① “No ID” is displayed when there is no Friend target.
- ① See page 18 for setting a Friend.

### Friends alarm

#### ● Function

You can select whether or not to sound an alarm when a vessel that is entered into the Friends list is detected.

**ON:** The alarm sounds when a vessel that is entered into the Friends list is detected, regardless of the set range.

**ON (in range):** The alarm sounds when a vessel that is entered into the Friends list is detected in the set range.

**OFF:** The alarm does not sound.

#### ● Range

Set the range to detect a vessel that is entered into the Friends list and sound the alarm to between 0.01 and 6.00 NM (in 0.01 NM steps), or between 0.02 and 11.11 km (in 0.01 km steps).

## ◇ NMEA settings

### NMEA 0183

Set the data transfer speed to 4800, 9600, 19200, or 38400 bps.

- ① Set an appropriate data transfer speed, depending on the equipment.

#### ● AIS out

The data transfer speed to transmit the data to an AIS transponder.

- ① The value is fixed at 38400 bps.

#### ● External GPS in

The data transfer speed to receive data from an external GPS receiver.

#### ● NMEA in/out

The data transfer speed to transmit or receive data from NMEA input or output pins.

### NMEA 2000

NMEA 2000 is a communication standard used to connect various marine devices and display units in the vessel.

The transponder can easily connect to an NMEA 2000 network with its plug-and-play functionality, and display the information provided from the devices on the network. Select the sensors in the NMEA 2000 network which sends data to the transceiver.

- ① See the next page for the compatible PGN list.

#### ● GPS

1. Open the “GPS” screen.

[MENU] > NMEA settings > NMEA 2000 > **GPS**

- The transponder starts searching the devices connected to the NMEA 2000 network.

- ① Push [CLR] to stop searching devices and display the device list.

2. Select the device to send the data to the transponder.

Device name: The selected device is used.

All: All devices are used.

Not used: No device is used.

- ① If the transponder is connected to both NMEA 0183 and NMEA 2000 devices, the NMEA 2000 device has priority. Select “Not Used” if you want to use NMEA 0183 devices.

3. Push [ENT] to display the Menu window.

- The Menu window is displayed.

4. Select “Select,” and then push [ENT] to set this item.

**TIP:** Select “Details,” and then push [ENT] to display the detail of the selected device.

# 7 MENU ITEMS

## Compatible PGN list

Receive			
059392	ISO Acknowledgment	126208	NMEA
059904	ISO Request	126996	Product Information
060160	ISO Transport Protocol, Data Transfer	129026	COG (Course Over Ground) and SOG (Speed Over Ground) - Rapid Update
060416	ISO Transport Protocol, Connection Management	129029	GNSS (Global Navigation Satellite System) Position Data
060928	ISO Address Claim	129545	GNSS RAIM Output
065240	ISO Commanded Address		

- ① When a received GPS signal does not include “129545 GNSS RAIM Output,” the transponder will not receive the signal from the external GPS receiver.

Transmit			
059392	ISO Acknowledgment	129540	GNSS Sats in View
059904	ISO Request	129545	GNSS RAIM Output
060416	ISO Transport Protocol, Connection Management	129792	AIS DGNSS Broadcast Binary Message
060928	ISO Address Claim	129793	AIS UTC and Date Report
126208	NMEA	129794	AIS Class A Static and Voyage Related Data
126464	PGN List	129797	AIS Binary Broadcast Message
126993	Heartbeat	129798	AIS SAR Aircraft Position Report
126996	Product Information	129801	AIS Addressed Safety Related Message
126998	Configuration Information	129802	AIS Safety Related Broadcast Message
129026	COG (Course Over Ground) and SOG (Speed Over Ground) - Rapid Update	129803	AIS Interrogation
129029	GNSS (Global Navigation Satellite System) Position Data	129805	AIS Data Link Management Message
129038	AIS Class A Position Report	129806	AIS Channel Management
129039	AIS Class B Position Report	129807	AIS Group Assignment
129040	AIS Class B Extended Position Report	129809	AIS Class B “CS” Static Data Report, Part A
129041	AIS Aids to Navigation (AtoN) Report	129810	AIS Class B “CS” Static Data Report, Part B
129539	GNSS DOPs	129811	AIS Single Slot Binary Message

## ◆ Configuration

### Backlight

You can set the Backlight mode to Day mode or Night mode.

① See page 10 for details.

### Key beep

You can select whether or not to sound a beep when a key is pushed.

ON: A beep sounds when a key is pushed.

OFF: No beep sounds for silent operation.

### Audible alarm

You can select whether or not to sound the following alarms.

ON: The alarm sounds.

OFF: The alarm does not sound.

- **CPA/TCPA**

The alarm for when the AIS target is closer than the set CPA/TCPA values.

- **Received message**

The alarm for when a message is received.

- **Arrival**

The alarm for when the vessel arrives at or near the destination

- **XTE**

The alarm for when the vessel goes off course.

- **Others**

The alarm except for the CPA/TCPA, Received message, Arrival, and XTE alarm.

### Internal GPS SBAS

The SBAS (Satellite Based Augmentation System) transmits signals to correct errors, and improve accuracy and reliability in data received from GPS satellites.

ON: This function is ON.

OFF: This function is OFF.

### Unit

You can select the unit to display a distance and speed.

NM, kn: "NM, kn" is used.

km, km/h: "km, km/h" is used.

### Language

You can select the display language.

Select English, Indonesian, Spanish, French, or Vietnamese.

## ◆ AIS information

### Own ship

Displays your vessel's AIS information.

OWN SHIP	1/5 ▶
LAT: 34°37.3859N	
LOX: 135°34.2980E	
SOG: 0.7 kn	
COG: 303.6°	
UTC: SEP/26/19	
05:17:01	

### AIS messages

- **RX log**

Displays the received messages.

① "No message" is displayed when there is no received message.

① See page 23 for details.

### Status

Displays your transponder's current status information.

STATUS
GPS: OK
TX OFF mode: OFF
TX time out: OK
TX power: OK
TX continuous: OK
ANT VSWR 3: OK

# 7 MENU ITEMS

## Status log

Displays the type, date, and time of the last 25 malfunctions that were detected.

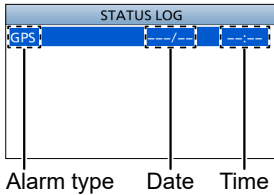

## ◇ Radio information

Displays your transponder's Serial number, Software version, AIS engine version, and GPS engine version.

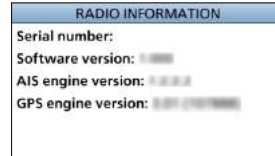

## Description of the alarm type

Alarm type	Description
GPS	Displayed when "GPS malfunction No GPS data" is detected.
TX power	Displayed when "TX malfunction No TX power" is detected.
TX continuous	Displayed when "TX malfunction Continuous TX" is detected.
ANT VSWR 3	Displayed when "Antenna malfunction High VSWR" is detected.
ANT VSWR 5	Displayed when "Antenna malfunction Open or Short" is detected.
RX	Displayed when "RX malfunction No RCV" is detected.
RX noise CH A	Displayed when "RX malfunction CH A noise level" is detected.
RX noise CH B	Displayed when "RX malfunction CH B noise level" is detected.
Input voltage	Displayed when the battery voltage drops to 9 V for 1 second. ①  is displayed.

**TIP:** You can delete the status log.

1. Push [▲] or [▼] to select a status log.
2. Push [ENT] to display the Menu window.
  - The Menu window is displayed.
3. Select "Delete," and push [ENT].
  - "Delete status log. Are you sure?" is displayed.
4. Select "OK," and push [ENT].

## ■ Supplied accessories

DC power cable

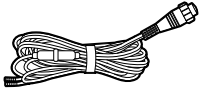

Mounting bracket

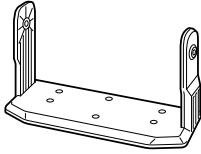

For the mounting bracket

Knob bolts



Flat washers (M5)



Screws

(5 × 20 mm)



Spring washers (M5)



Accessory connector



GPS antenna

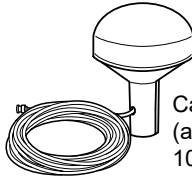

Cable length  
(approximate):  
10 m, 32.8 ft

For the GPS antenna  
Mounting bracket

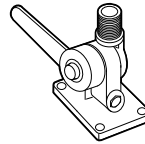

7

8

## ◇ Accessory connector set up

The accessory connector is used on the accessory cable.

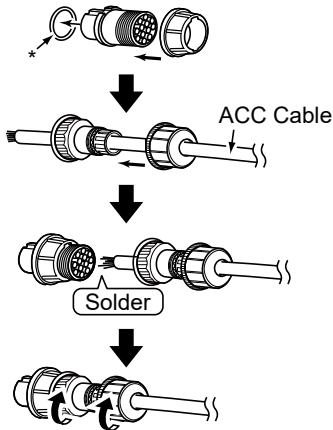

\* Be sure to set this ring to keep the waterproof capability.

## 8 CONNECTIONS AND INSTALLATION

### ■ GPS antenna connection

**NOTE:** Be sure the GPS antenna is positioned where the GPS antenna has a clear view to receive signals from satellites.

#### ◇ Installation

1. Mount the bracket securely to the desired position.  
① Screws for mounting the bracket are user supplied.
2. Insert the GPS antenna to the bracket, and then rotate it clockwise until it is completely tightened.

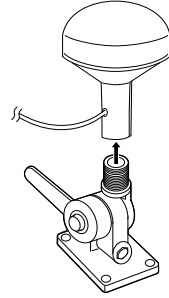

#### ◇ Connection

- Insert the GPS antenna cable to the GPS antenna connector, and then rotate it clockwise until it is completely tightened. (p. 40)

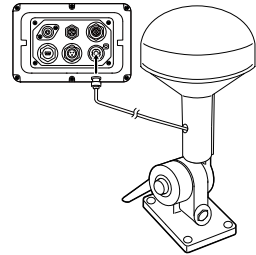

#### ◇ Attention

##### About calculating position

The GPS antenna acquires signals from GPS satellites. It calculates its position by the orbit information of the GPS satellites and needs to measure the distance between itself and three or more GPS satellites to obtain a reliable position. The GPS antenna acquires all available satellites when it is powered up. Normally, it takes approximately 1 minute to determine a position.

In places where the GPS signals cannot reach the GPS antenna, it may show position errors (misplacement) or no position reading at all.

As the satellites are continuously moving, measurement of the position or time by the GPS antenna may take a while, and/or no position reading can be made in some instances. Even if the GPS antenna acquires signals from three or more GPS satellites, it may take a longer time to determine a position depending on the satellite locations.

##### Location precision

The GPS device automatically calculates its position when it acquires signals from three or more GPS satellites.

The position error using the GPS is about  $\pm 10$  meters. However, this can vary up to several hundred meters, depending on the surrounding environment. The GPS information and its accuracy varies, depending on the GPS system being acquired, place and time.

##### About NMEA sentences

When the current position data cannot be received due to the GPS signal being blocked by something, the GPS antenna sends the last memorized NMEA sentence, but the sentence may include invalid data.



## ■ Connections

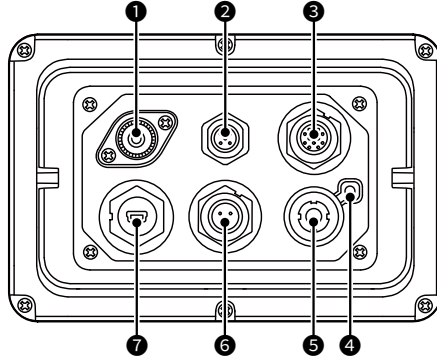

### 1 VHF ANTENNA CONNECTOR

Connects to a marine VHF antenna with a PL-259 connector.

A key element in the performance of any communication system is the antenna. Ask your dealer about antennas and the best place to mount them.

**CAUTION: DO NOT** transmit without an antenna.

### 2 NMEA 2000 CONNECTOR

Connects to the NMEA 2000 network.

#### Requirements of the external GPS:

- “GNSS RAIM Output” can be input using the RAIM function.
- The external GPS antenna must be installed within 26 m (85.3 ft) from the internal GPS antenna.

### 3 NMEA 0183 CONNECTORS

Connects to a transceiver, plotter device, marine radar, external GPS receiver, or switch button.

① See page 41 for the connector information.

#### Requirements of the external GPS:

- The datum of the external GPS receiver must be “WGS-84.”
- GBS sentence can be input using the RAIM function.
- The external GPS antenna must be installed within 26 m (85.3 ft) from the internal GPS antenna.

### 4 GROUND TERMINAL

Connects to a vessel ground to prevent electrical shocks and interference from other equipment occurring. Use a self tapping screw (3 × 6 mm: not supplied).

### 5 GPS ANTENNA CONNECTOR

Connects to the supplied GPS antenna.

① See page 39 for the GPS antenna connection.

### 6 DC POWER CONNECTOR

Connects to a 12 or 24 V DC power source. (+: Red, -: Black)

### 7 DATA CONNECTOR

Connects to a PC using a USB cable (A - mini B type) to output the received AIS messages, output GPS data, program the transponder, or update a firmware.

① A USB cable (A - mini B type) is user supplied.

① If the transponder is turned ON or OFF while communicating with an application software on the PC, the PC software may not work normally. In that case, restart the PC software.

# 8 CONNECTIONS AND INSTALLATION

## ◇ Connector information

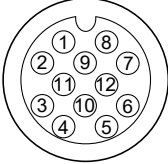
NMEA 0183				
				
Pin	Pin name	Specification	Sentence format	Description
1	GND	–	–	Connects to ground.
2	NMEA IN (–)	Input level: Less than 2 mA (at 2 V applied)	–	Connects to the NMEA input/ output connector of a transceiver to output GPS data, or to transmit an Individual DSC call. (p. 31)
3	NMEA IN (+)			
4	NMEA OUT (–)	Output level: 5 V/40 mA (maximum) (RS-422 balanced type)	GGA, GNS, GLL, GSA* <sup>1</sup> , GSV* <sup>1</sup> , RMC, VTG, GBS, DTM, DSC	The data communication speed (baud rate) can be selected between 4800 bps (IEC61162-1) and 38400 bps (IEC61162-2) for each Input/Output port. (Default: 4800 bps)
5	NMEA OUT (+)			
6	AIS OUT (–)	Output level: 5 V/40 mA (maximum) (RS-422 balanced type)	VDM, VDO, ACA, ACS, ALR, TXT, GGA* <sup>3</sup> , GNS* <sup>3</sup> , GLL* <sup>3</sup> , RMC* <sup>3</sup> , VTG* <sup>3</sup>	Connects to a plotter device or marine radar to output the received AIS messages and GPS data. The data communication speed (baud rate) is fixed at 38400 bps (IEC61162-2).
7	AIS OUT (+)			
8	EXT GPS IN (–)	Input level: Less than 2 mA (at 2 V applied)	GGA, GNS, GLL, RMC, VTG, GBS* <sup>2</sup> , DTM	Connects to an external GPS receiver to input GPS data. The data communication speed (baud rate) can be selected between 4800 bps (IEC61162-1) and 38400 bps (IEC61162-2). (Default: 4800 bps)
9	EXT GPS IN (+)			
10	TX OFF	Active: Connect to ground	–	Connects to a switch button to turn OFF the TX function. When a short occurs between pins 1 and 10, transmission is inhibited.
11	ALERT	Load rating: DC 3.3 V/1 mA (maximum)	–	An active logic is set to High level while an alarm sounds if a malfunction occurs, an AIS target is closer than your CPA and TCPA settings, or so on.
12	NC	–	–	–

\*1 Only 38400 bps.

\*2 When a received GPS signal does not include a GBS sentence, the transponder will not receive the signal from the external GPS receiver.

\*3 May not be sent, depending on the presetting.

**NOTE:**

- When an external GPS receiver is not connected, RMC, GSA, and GSV sentences are only output from the internal receiver.
  - When the NMEA sentences are input from an external GPS receiver, all the sentences\*, as described to the left, are passed to the output terminal.
- \*The external GPS receiver requires the GBS sentence output.

**■ Connecting to the transceiver**

Connect the transponder and a transceiver using the accessory cable. After connecting, an Individual DSC call can be made to the AIS target using the transponder without entering the target's MMSI code. (p. 31)

Connect each lead to the appropriate lead as follows.

See the instruction manual of each for transceiver's connecting instructions.

- ① The following transceivers can operate with this function. (As of November 2019)
- IC-M605/IC-M605EURO/IC-M506/IC-M506GE/IC-M424G/IC-M400BB/  
IC-M330/IC-M330GE/IC-M330G/IC-M220

**8**

**◇ IC-M605/IC-M605EURO**

- NMEA 1 OUT (+) or NMEA 2 OUT(+): To NMEA IN (+).
- NMEA 1 OUT (-) or NMEA 2 OUT(-): To NMEA IN (-).
- NMEA 1 IN (+) or NMEA 2 IN (+): To NMEA OUT (+).
- NMEA 1 IN (-) or NMEA 2 IN (-): To NMEA OUT (-).

**IC-M605/IC-M605EURO's rear panel view**

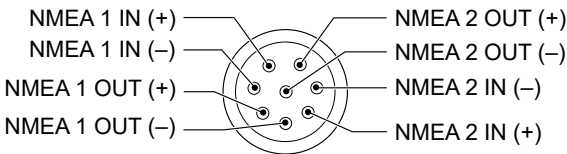

**◇ IC-M506/IC-M506GE/IC-M424G/IC-M400BB/  
IC-M330/IC-M330GE/IC-M330G/IC-M220**

- Listener A (Data-H) (Yellow): To NMEA OUT (+).
- Listener B (Data-L) (Green): To NMEA OUT (-).
- Talker A (Data-H) (White): To NMEA IN (+).
- Talker B (Data-L) (Brown): To NMEA IN (-).

**■ Fuse replacement**

One fuse is installed in the supplied DC power cable. If the fuse blows or the transponder stops functioning, track down the source of the problem, repair it, and replace the damaged fuse with a new one of the proper rating.

Fuse rating: 3 A

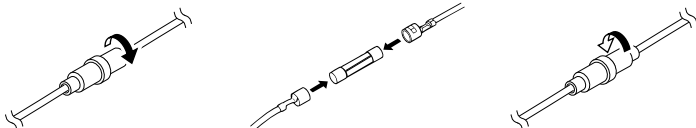

## 8 CONNECTIONS AND INSTALLATION

### ■ Mounting the transponder

#### ◇ Using the supplied mounting bracket

You can mount the transponder on a dashboard using the universal mounting bracket supplied with your transponder.

**CAUTION: KEEP** the transponder at least 1 meter (3.3 ft) away from the vessel's magnetic navigation compass.

1. Mount the bracket securely to a surface which is more than 10 mm (0.39 in) thick and can support more than 3 kg (6.6 lb) using the 4 supplied screws (5 × 20 mm).

**NOTE:** When mounting the transponder on a board, fix the bracket to the board using the user supplied bolts and nuts, as shown below.

2. Attach the transponder to the bracket so that the face of the transponder is at 90° to your line of sight when operating it.
  - ① Adjust the function display angle to be easy-to-read.

#### Mounting Example

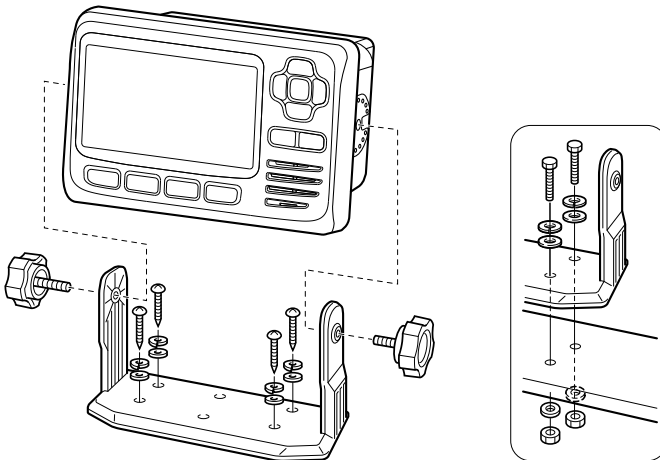

## ■ MB-132 installation

An optional MB-132 FLUSH MOUNT KIT is used to mount the transponder to a flat surface such as an instrument panel.

**CAUTION:** Keep the transponder at least 1 meter (3.3 feet) away from your vessel's magnetic navigation compass.

1. Using the template on page 50, carefully cut a hole in the instrument panel, or wherever you plan to mount the transponder.
2. Slide the transponder through the hole, as shown to the right.

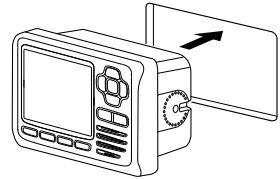

3. Attach the clamps on both sides of the transponder using 2 supplied (M5 × 8 mm) bolts.
  - ⓘ Make sure that the clamps align parallel to the transponder's body.

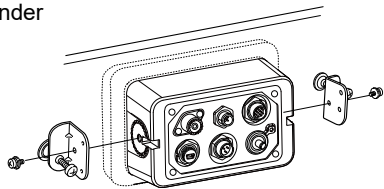

4. Tighten the end bolts on the clamps (rotate clockwise) so that the clamps press firmly against the inside of the instrument control panel. (Torque: 0.6 N•m)

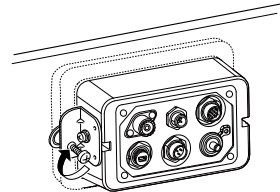

5. Tighten the locking nuts (rotate counterclockwise) so that the transponder is securely mounted in position, as shown to the right.

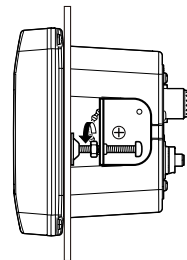

6. Connect the antenna and power cables, then return the instrument control panel to its original place.

## ■ Specifications

① All stated specifications are subject to change without notice or obligation.

General		
Frequency coverage	AIS	161.500 ~ 162.025 MHz
	DSC	156.525 MHz
Type of emission	AIS	16K0GXW (GMSK)
	DSC	16K0G2B
Antenna impedance	50 Ω nominal	
Intermediate frequency	CH-A	1st: 21.700 MHz, 2nd: 450 kHz
	CH-B	1st: 30.150 MHz, 2nd: 450 kHz
Operating temperature range	-20°C ~ +60°C, -4°F ~ +140°F	
Power supply requirement	Negative ground: 12 V or 24 V DC nominal (9.6 ~ 31.2 V)	
Current drain (at 12 V DC)	TX	1.5 A
	RX	0.7 A
Dimensions (approximate) (projections not included)	166.2 (W) × 110.2 (H) × 92.5 (D) mm 6.5 (W) × 4.3 (H) × 3.6 (D) in	
Weight (approximate)	700 g, 1.5 lb	

Transmitter		
Transmit power	2 W	
Modulation	16K0GXW (GMSK)	
Conducted spurious emissions	Less than -36 dBm (9 kHz ~ 1 GHz)	
	Less than -30 dBm (1 ~ 4 GHz)	

Receiver (AIS)		
Sensitivity	Less than -110 dBm	
Co-channel	More than -111 dBm	
Adjacent channel selectivity	More than -31 dBm	
Intermodulation	More than -36 dBm	
Spurious response	More than -31 dBm	
Blocking	More than -15 dBm (±0.5 ~ ±5 MHz)	
	More than -23 dBm (±5 ~ ±10 MHz)	
Conducted spurious emissions	Less than -57 dBm (9 kHz ~ 1 GHz)	
	Less than -47 dBm (1 ~ 4 GHz)	

Receiver (DSC)		
Sensitivity	Less than -110 dBm	
Co-channel	More than -114 dBm	
Adjacent channel selectivity	More than 70 dB	
Intermodulation	More than -39 dBm	
Spurious response	More than -34 dBm	
Blocking	More than -20 dBm	

<b>GPS Receiver</b>	
Received frequency	1575.42 MHz
Acquisition	72 ch (maximum)
Differential satellites	WAAS, EGNOS, MSAS, GAGAN
Dimensions (approximate) (including mounting bracket)	96.2 (W) × 225 (H) mm 3.8 (W) × 8.9 (H) in
Weight (approximate)	700 g, 1.5 lb (including cable and mounting bracket)
Cable length (approximate)	10 m, 32.8 ft

◇ **Dimensions**

Unit: mm (inch)

**MA-510TR**

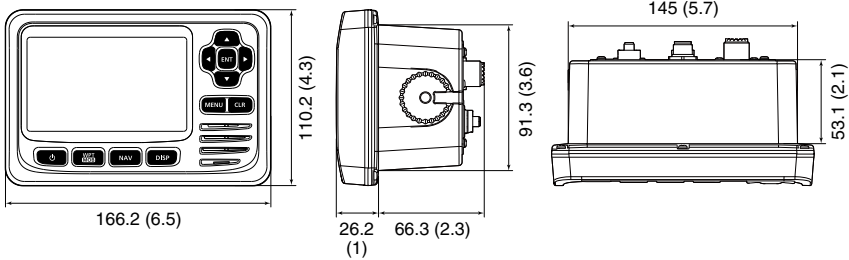

**MA-510TR with the mount bracket**

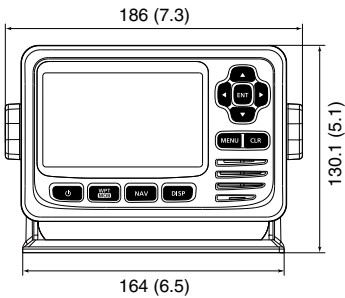

**GPS antenna**

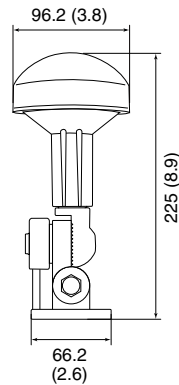

■ **Options**

- **MB-132/MB-75 FLUSH MOUNT KIT**  
To mount the transponder to a panel.

## ■ Troubleshooting

### **The transponder does not turn ON.**

- Bad connection to the power supply.  
→ Check the connection to the transponder and power supply. (p. 40)
- The fuse is blown.  
→ Repair the problem, and then replace the fuse. (p. 42)

### **You cannot transmit.**

- 1 minute has not passed from turning ON the transponder.  
→ Wait for 1 minute from turning ON the transponder.

### **The Main screen is not displayed.**

- The result of the self check is "failed" (No Good).  
→ Hold down [⏻] for 1 second to turn OFF the transponder, and then push to turn it ON again to reset the transponder. (p. 9)

### **The "Searching GPS" screen does not disappear.**

- The transponder is still searching for GPS satellites.  
→ Wait until the transponder detects a GPS satellite. (p. 9)
- The GPS antenna is not connected to the transponder.  
→ Connect the GPS antenna to the transponder. (p. 40)

### **The collision alarm does not sound.**

- The collision alarm function is OFF.  
→ Turn ON the collision alarm function. (p. 21)
- The audible alarm function is OFF.  
→ Set to "ON" to sound an alarm. (p. 36)



## ■ Error messages

An error message is displayed when a malfunction occurs that has an error message programmed for it.

Message contents	Description
GPS malfunction No GPS data	Displayed when no GPS data is received for 60 seconds.
RX malfunction No RCV	Displayed when the transponder receive circuit has failed.
RX malfunction CH A noise level	Displayed when excessively strong atmospheric noise, or noise signals from other navigation equipment, are received on Channel A.
RX malfunction CH B noise level	Displayed when excessively strong atmospheric noise, or noise signals from other navigation equipment, are received on Channel B.
TX malfunction No TX power	Displayed when no RF power is output, or the transmit circuit has failed.
TX malfunction Continuous TX	Displayed when the protective circuit cuts off the AIS signal after 1 second of continuous transmission.
Antenna malfunction High VSWR	Displayed when the high VSWR* is detected (the antenna is mismatched) for 5 minutes. *Voltage Standing Wave Ratio
Antenna malfunction Open or Short	Displayed when the antenna is open or shorted.

# 11 AtoN CODE DESCRIPTION

The following table lists all the AtoN codes that are displayed on the detail screens of an “AtoN” or “AtoN virtual.” (p. 20)

## Type of AtoN

Code	Description
0	Default, Type of AtoN not specified
1	Reference point
2	RACON
3	Fixed structures off-shore, such as oil platforms, wind farms.
4	Emergency Wreck Marking Buoy
5	Light, without sectors
6	Light, with sectors
7	Leading Light Front
8	Leading Light Rear
9	Beacon, Cardinal N
10	Beacon, Cardinal E
11	Beacon, Cardinal S
12	Beacon, Cardinal W
13	Beacon, Port hand
14	Beacon, Starboard hand
15	Beacon, Preferred Channel port hand
16	Beacon, Preferred Channel starboard hand
17	Beacon, Isolated danger
18	Beacon, Safe water
19	Beacon, Special mark
20	Cardinal Mark N
21	Cardinal Mark E
22	Cardinal Mark S
23	Cardinal Mark W
24	Port hand Mark
25	Starboard hand Mark
26	Preferred Channel Port hand
27	Preferred Channel Starboard hand
28	Isolated danger
29	Safe Water
30	Special Mark
31	Light Vessel/LANBY/Rigs

# TEMPLATE 12

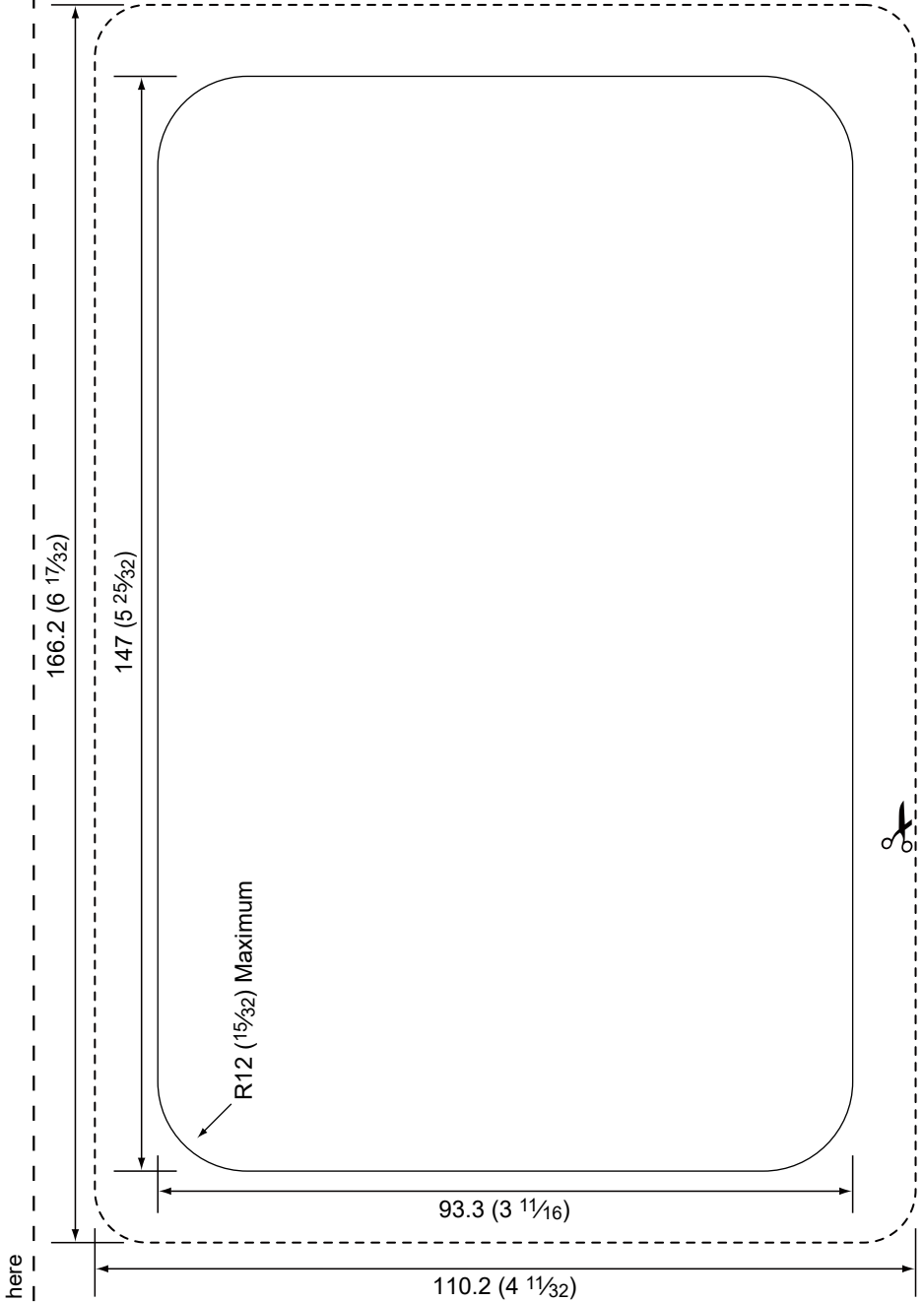

11

12

Unit: mm (inch)



<b>A</b>		<b>L</b>		<b>O</b>	
AIS		Language		Options .....	46
About AIS .....	1	Configuration .....	36	Own ship data	
AIS classes .....	1	Lost target .....	30	Entering .....	5
AIS list				Items .....	6
Danger list .....	17	<b>M</b>		<b>S</b>	
Friends list .....	17	Main screen		Specifications .....	45
Target list .....	17	AIS .....	12	<b>T</b>	
Using .....	16	AIS and Highway ....	14	Template .....	50
AtoN code		AIS and Steering ....	13	Transceiver	
Description .....	49	Highway .....	14	Connecting .....	42
Audible alarm		Information box .....	15	Individual DSC call..	31
Configuration .....	36	Using .....	11	<b>U</b>	
<b>B</b>		MB-132 installation .....	44	Unit	
Backlight		Menu		Configuration .....	36
Configuration .....	36	Construction .....	7	<b>V</b>	
Function .....	10	Description .....	33	Vendor ID	
<b>D</b>		Items .....	32	Information .....	20
Detail screen .....	19	Selecting .....	8	<b>W</b>	
DSC		Message		Waypoint	
Individual DSC call..	31	Logs .....	23, 36	Deleting .....	26
<b>E</b>		Receiving .....	23	Editing .....	26
Error messages .....	48	MMSI code		Entering .....	25
<b>F</b>		Entering .....	4	List .....	24
Friend		MOB		Navigating .....	24
Alarm .....	34	Starting .....	27		
Deleting .....	18	Stopping .....	27		
Entering .....	18	Mounting .....	43		
List .....	17, 34	<b>N</b>			
Front panel .....	2	Navigation			
Function display .....	3	Resetting .....	29, 33		
<b>G</b>		Settings .....	33		
GPS antenna		Starting .....	28		
Connection .....	39	Stopping .....	29		
Installation .....	39	NMEA 0183			
<b>K</b>		Connections .....	40		
Key beep		Information .....	41		
Configuration .....	36	Settings .....	34		
		NMEA 2000			
		Compatible PGN list..	35		
		Connections .....	40		
		Settings .....	34		

---

MEMO

---

---

---

---

---

---

---

---

---

---

---

---

---

---

---

---

---

---



**Count on us!**

